

InLine Enclosure Hinge Cover Type 4, 250x200x150mm, Light Gray, Mild Steel



CATALOG NUMBER

LHC252015

Aesthetic styling, with an attractive, durable light-gray finish, makes InLine Enclosures an excellent choice when style and functionality are important. InLine Enclosures have an outward formed flange to prevent contaminants from entering the enclosure and are available in three versions: window door, hinged solid door and solid screw cover.

INDUSTRY STANDARDS

UL 508A Listed; Type 3, 4, 12; File No. E61997
cUL Listed per CSA C22.2 No. 94; Type 3, 4, 12; File No. E61997

Mounting brackets required to meet UL/CSA external mounting requirements.

NEMA/EEMAC Type 4 and 12

IEC 60529, IP66

FEATURES

Metric dimensions

16 gauge steel

Seams continuously welded and ground smooth

External formed body flange channels away liquids

Large perimeter body opening

Mounting holes in back of body for direct mounting or optional external mounting brackets

Seamless foam-in-place gasket

Grounding stud on the body

Bonding provision on the door

Hardware kit includes panel mounting screws, grounding hardware and sealing washers for wall-mounting holes

Installation instructions

PRODUCT ATTRIBUTES

Article Number: 61100

Height (H): 9.84in

Width (W): 7.87in

Depth (D): 5.91in

Material: Mild Steel

Finish: Powder Coated

Color: Light Gray

Color Code: RAL 7035

Thickness (T): 16ga

Mounting (G x H): 9.12 x 5.33in

Weight: 6.6lb

DIAGRAMS

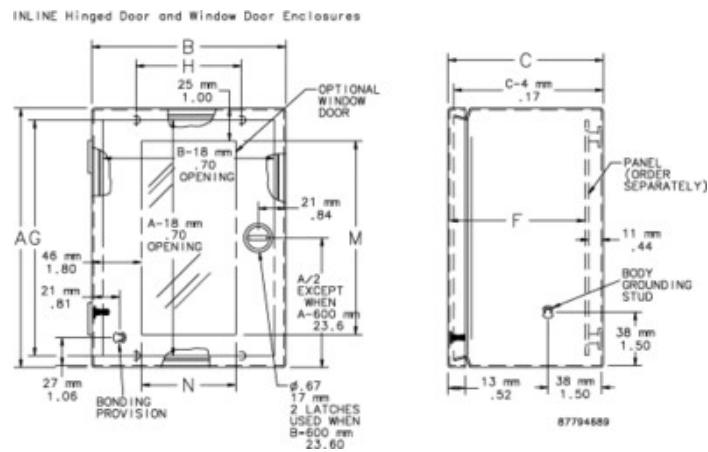

WARNING

nVent products shall be installed and used only as indicated in nVent's product instruction sheets and training materials. Instruction sheets are available at www.nvent.com and from your nVent customer service representative. Improper installation, misuse, misapplication or other failure to completely follow nVent's instructions and warnings may cause product malfunction, property damage, serious bodily injury and death and/or void your warranty.



Our powerful portfolio of brands:

CADDY ERICO HOFFMAN ILSCO SCHROFF TRACHTE