

Concept EMC Enclosure Type 4, 24.00x20.00x6.00, Light Gray, Mild Steel



CATALOG NUMBER

CSD24206LGEMC

Use stylish Concept EMC Enclosures with their convenient quarter-turn latches in indoor or outdoor applications to contain stray electromagnetic interference (EMI) signals produced by internal components and to shield those components from external EMI/RFI interference.

INDUSTRY STANDARDS

UL 508A Listed; Type 4, 12; File No. E61997

cUL Listed per CSA C22.2 No. 94; Type 4, 12; File No. E61997

Mounting brackets required to meet UL/CSA external mounting requirement.

NEMA/EEMAC Type 4, 12, 13

IP66

IEC 60529, IP66

FEATURES

Seams continuously welded and ground smooth

Minimum width body flange provides maximum door opening

External formed body flange channels away liquids

Panel mounting studs fit optional Concept panels and other accessories

Mounting holes in back of body for direct mounting or for optional external mounting brackets

Removable door with hidden hinges for clean, aesthetic appearance

Door opens 210 degrees

Corner-formed door

Hinge mounting brackets for wire management or optional accessories

Stainless steel spring finger EMI/RFI gasket

Quarter-turn latches

Grounding stud on body

Door bars provided for wire management and bonding

Hardware kit includes panel mounting nuts screws, grounding hardware and sealing washers

Simple easy-to-remove and install hinge pins with built-in captivation clip

High-torque threadless studs and fasteners on door

Illustrated instruction sheet

PRODUCT ATTRIBUTES

Article Number: 25729

Height (H): 24in

Width (W): 20in

Depth (D): 6in

Material: Mild Steel

Finish: Powder Coated

Color: Light Gray

Color Code: RAL 7035

Body Thickness: 18ga

Door Thickness: 16ga

Mounting (G x H): 22.50 x 18.50in

Latch Quantity: 1

Weight: 32.7lb

ADDITIONAL PRODUCT DETAILS

Purchase panels separately.

DIAGRAMS

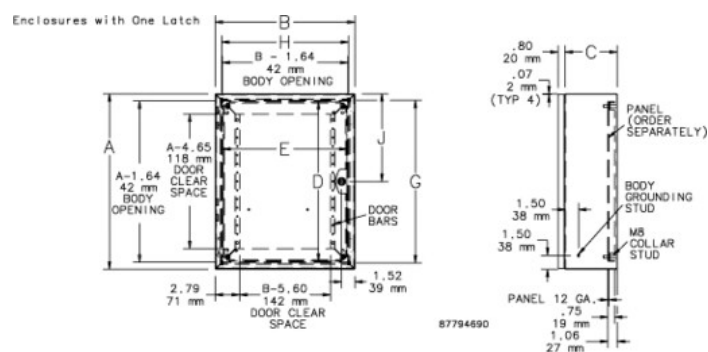

WARNING

nVent products shall be installed and used only as indicated in nVent's product instruction sheets and training materials. Instruction sheets are available at www.nvent.com and from your nVent customer service representative. Improper installation, misuse, misapplication or other failure to completely follow nVent's instructions and warnings may cause product malfunction, property damage, serious bodily injury and death and/or void your warranty.



Our powerful portfolio of brands:

CADDY ERICO HOFFMAN ILSCO SCHROFF TRACHTE