

## DRL273524L

**Weidmüller Interface GmbH & Co. KG**  
 Klingenbergstraße 26  
 D-32758 Detmold  
 Germany

www.weidmueller.com

## Product image



Similar to illustration

Individual relays within the D-SERIES DRL

- 2 CO contacts
- Optional AC or DC coils
- With integrated status LED

## General ordering data

Version	D-SERIES DRL, Relay, Number of contacts: 2, CO contact AgSnO, Rated control voltage: 24 V AC, Continuous current: 10 A, Flat blade connections (4.8 mm x 0.5 mm), Test button available: No
Order No.	<a href="#">2765400000</a>
Type	DRL273524L
GTIN (EAN)	4064675076797
Qty.	20 items

## Technical data

### Approvals

Approvals



ROHS	Conform
UL File Number Search	<a href="#">UL Website</a>
Certificate No. (cURus)	E312083

### Dimensions and weights

Depth	36 mm	Depth (inches)	1.4173 inch
Height	28 mm	Height (inches)	1.1024 inch
Width	21.5 mm	Width (inches)	0.8465 inch
Net weight	36.55 g		

### Temperatures

Storage temperature	-25 °C...55 °C	Ambient temperature	-25 °C...55 °C
Operating temperature		Humidity	35 % to 85 % relative humidity level

### Environmental Product Compliance

RoHS Compliance Status	Compliant without exemption
REACH SVHC	No SVHC above 0.1 wt%

### Rated data UL

Certificate No. (cURus)	E312083
-------------------------	---------

### Control side

Rated control voltage	24 V AC	Rated current AC	54 mA
Power rating	1.2 VA	Coil resistance	180 Ω ± 10 %
Status indicator	red LED		

### Load side

Rated switching voltage	250 V AC	Continuous current	10 A
Max. switching frequency at rated load	0.1 Hz	Max. switching voltage, AC	250 V
Inrush current	50 A / 50 ms	AC switching capacity (resistive), max.	2500 VA
DC switching capacity (resistive), max.	300 W @ 24 V	Switch-on delay	<20 ms
Switch-off delay	<20 ms	Contact type	2 CO contact (AgSnO)
Mechanical service life	10 x 10 <sup>6</sup> switching cycles	Min. switching power	10 mA @ 12 V

### General data

Test button available	No	
Mechanical switch position indicator	Yes	
Colour	Transparent	
UL94 flammability rating component	Component	Relay cover
	UL94 flammability rating	V-2
	Component	Relay baseplate
	UL94 flammability rating	V-0
Component	Relay status indicator	
	UL94 flammability rating	HB

## Technical data

### Insulation coordination

Rated voltage	250 V	Pollution severity	3
Surge voltage category	III	Insulating material group	IIIa
Clearance and creepage distances for control side - load side	≥ 4 mm	Dielectric strength for control side - load side	2.5 kVeff / 1 min
Dielectric strength of neighbouring contacts	1.2 kVeff / 1 min.	Dielectric strength of open contact	2 kVeff / 1 min
Impulse withstand voltage	5 kV (1.2/50 µs)	Protection degree	IP20

### Further details of approvals / standards

Certificate No. (cURus)	E312083
-------------------------	---------

### Connection data

Wire connection method	Flat blade connections (4.8 mm x 0.5 mm)
------------------------	---

### Classifications

ETIM 8.0	EC001437	ETIM 9.0	EC001437
ETIM 10.0	EC001437	ECLASS 14.0	27-37-16-01
ECLASS 15.0	27-37-16-01		

Drawings

Wiring diagram

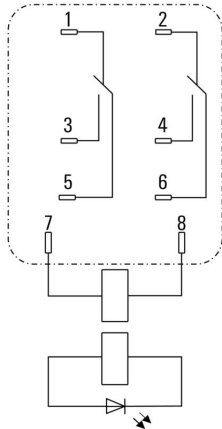

View of Pins from below

DC load limit curve

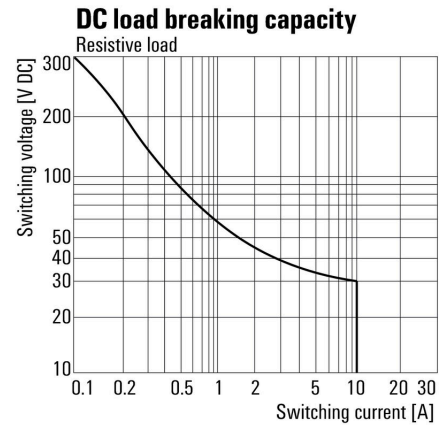

DC load limit curve Resistive load

Graph

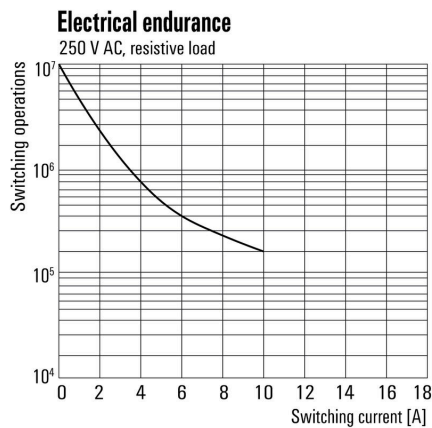

Electrical service life

Graph

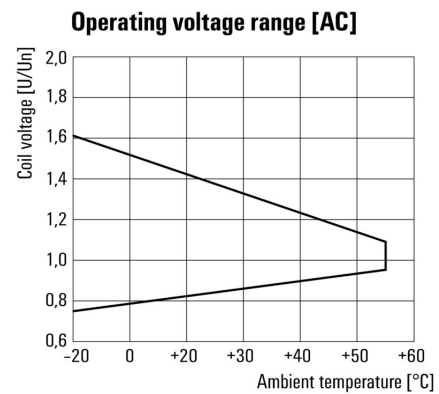

DC operational voltage range

Dimensional drawing

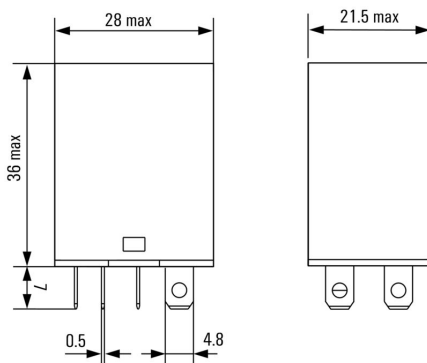

**Miscellaneous**

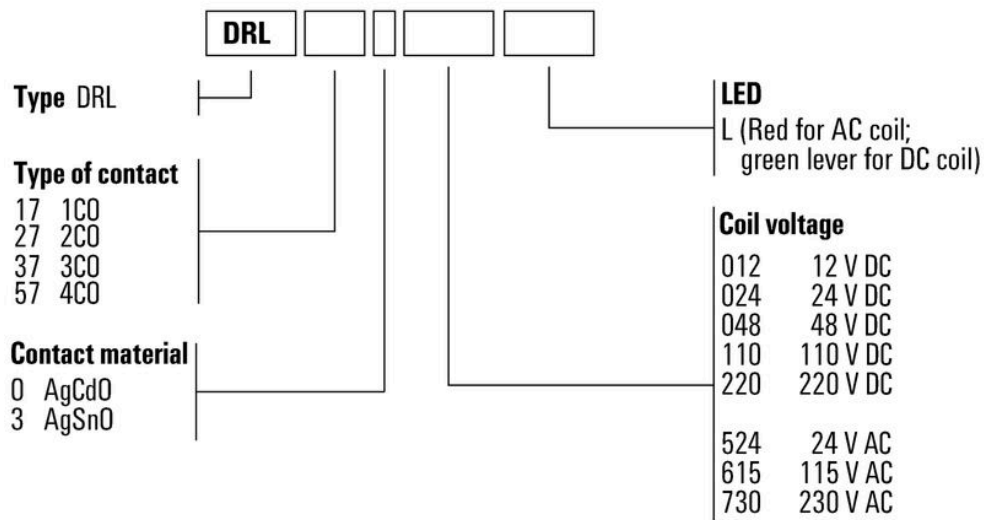

Type codes

## DRL273524L

**Weidmüller Interface GmbH & Co. KG**  
 Klingenbergstraße 26  
 D-32758 Detmold  
 Germany

www.weidmueller.com

## Accessories

## Sockets



Relay sockets for the D-SERIES DRL relays

- 2, 3 and 4 CO contacts
- Screw connection

## General ordering data

Type	SLD F 2CO	Version	
Order No.	<a href="#">7760056225</a>	D-SERIES DRL, Relay socket, Number of contacts: 2, CO contact,	
GTIN (EAN)	6944169634017	Continuous current: 10 A, Screw connection	
Qty.	10 ST		

## Retaining clips

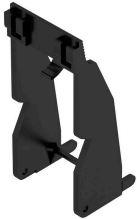

Retaining clip for D-SERIES DRM relays

- Metal and plastic retaining clip

## General ordering data

Type	DRM/DRL CLIP M	Version	
Order No.	<a href="#">7760056108</a>	D-SERIES, Retaining clip	
GTIN (EAN)	4032248855568		
Qty.	10 ST		

## LED



Pluggable protective modules for the D-SERIES relay sockets, with optional protective functions.

- With green LED

## General ordering data

Type	RIM 3 6/24VUC	Version	
Order No.	<a href="#">7940018457</a>	D-SERIES, LED module, Rated control voltage: 6...24 V UC, Plug-in connection	
GTIN (EAN)	4032248878192		
Qty.	10 ST		

## DRL273524L

**Weidmüller Interface GmbH & Co. KG**  
 Klingenbergstraße 26  
 D-32758 Detmold  
 Germany

www.weidmueller.com

## Accessories

Type	RIM 3 24/60VUC	Version	
Order No.	<a href="#">7760056018</a>	D-SERIES, LED module, Rated control voltage: 24...60 V UC, Plug-in connection	
GTIN (EAN)	4032248878130		
Qty.	10 ST		

## Blank

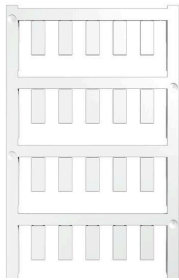

ESG is the tried-and-tested marker in MultiCard format for use on many well-known electrical devices. The result is high-quality device marking with a high-contrast appearance.

Various types are available for devices from manufacturers like Siemens, ABB, Beckhoff etc.

Advantages at a glance:

- Tags for universal usage, self-adhesive or clip-on tags, depending on type
- For aligned equipment, e.g. circuit breakers, we supply ESG markers for clipping onto tag rails
- Individual laser-quality printing according to specifications

For custom printing: Please send us a file of our labeling software M-Print PRO or M-Print PRO Online (without installation) for your labeling specifications.

## General ordering data

Type	ESG 6/15 K MC NE WS	Version	
Order No.	<a href="#">188010000</a>	ESG, Device markers x 15 mm, PA 66, Colour: white, Self-adhesive	
GTIN (EAN)	4032248478781		
Qty.	200 ST		
Type	ESG 6/15 K MC NE GE	Version	
Order No.	<a href="#">188013000</a>	ESG, Device markers x 15 mm, PA 66, Colour: yellow, Self-adhesive	
GTIN (EAN)	4032248478910		
Qty.	200 ST		
Type	ESG 6/17 K MC NE GE	Version	
Order No.	<a href="#">188011000</a>	ESG, Device markers x 17 mm, PA 66, Colour: yellow, Self-adhesive	
GTIN (EAN)	4032248478798		
Qty.	200 ST		
Type	ESG 6/17 K MC NE WS	Version	
Order No.	<a href="#">188012000</a>	ESG, Device markers x 17 mm, PA 66, Colour: white, Self-adhesive	
GTIN (EAN)	4032248478804		
Qty.	200 ST		

## ESG 6/15



Guaranteed long service life: ESG

The multi-colour and multi-format labels have a strong adhesive layer to ensure the best possible adhesion to the underlying surface. Double laminated polyester makes the basic material very thin and yet extremely tear-resistant.

Your benefits with MultiMark

- "Different materials for various requirements"
- Can be used with equipment from many manufacturers
- Device markers with a familiar design

## DRL273524L

**Weidmüller Interface GmbH & Co. KG**  
Klingenbergstraße 26  
D-32758 Detmold  
Germany

[www.weidmueller.com](http://www.weidmueller.com)

## Accessories

### General ordering data

Type	ESG 6/15 MM WS	Version	
Order No.	<a href="#">2619940000</a>	ESG, Device markers, 6 x 15 mm, white	
GTIN (EAN)	4050118626148		
Qty.	3000 ST		

### ESG 6/17



#### Guaranteed long service life: ESG

The multi-colour and multi-format labels have a strong adhesive layer to ensure the best possible adhesion to the underlying surface. Double laminated polyester makes the basic material very thin and yet extremely tear-resistant.

#### Your benefits with MultiMark

- "Different materials for various requirements"
- Can be used with equipment from many manufacturers
- Device markers with a familiar design

### General ordering data

Type	ESG 6/17 MM WS	Version	
Order No.	<a href="#">2005100000</a>	ESG, Device markers, 6 x 17 mm, white	
GTIN (EAN)	4050118390728		
Qty.	3000 ST		



## Counterpart

### Sockets



- Relay sockets for the D-SERIES DRL relays
- 2, 3 and 4 CO contacts
  - Screw connection

### General ordering data

Type	SLD F 2CO	Version	
Order No.	<a href="#">7760056225</a>	D-SERIES DRL, Relay socket, Number of contacts: 2, CO contact,	
GTIN (EAN)	6944169634017	Continuous current: 10 A, Screw connection	
Qty.	10 ST		