

MST 1-PHASE CONTROL AND ISOLATION TRANSFORMER

P: 1000VA IN: 208...550VAC OUT: 2x115VAC

Single-phase - Control and Isolation Transformers
 1000 VA
 Isolation class T 40/B
 Other voltages on request.

[Link to Product](#)

Illustration

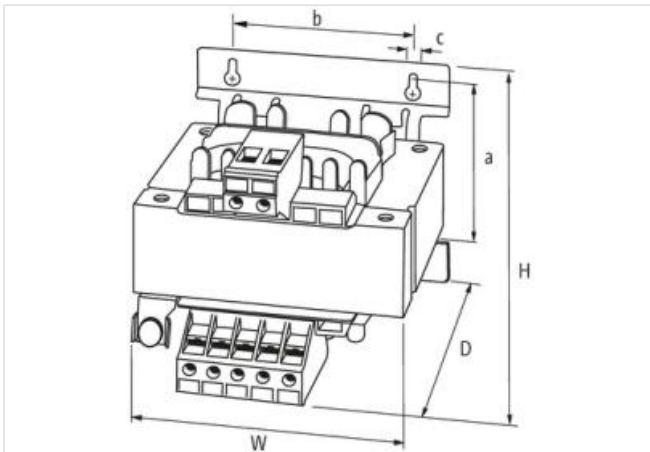
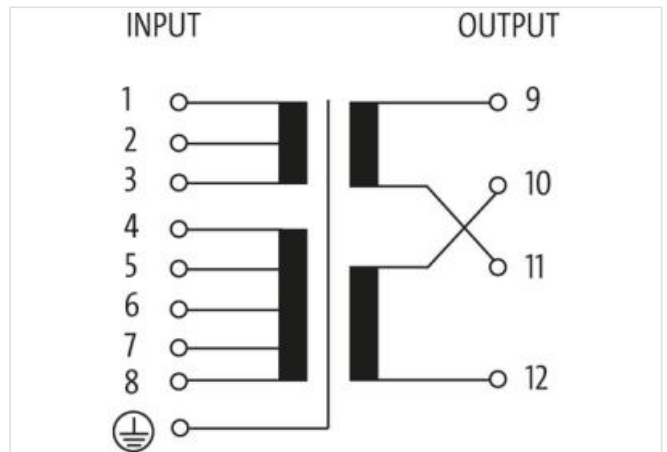

Product may differ from Image



Commercial data

ECLASS-6.0	27031302
ECLASS-6.1	27031302
ECLASS-7.0	27031302
ECLASS-8.0	27031302
ECLASS-9.0	27031302
ECLASS-10.1	27031302

The information in this Product-PDF has been compiled with the utmost care. Liability for the correctness completeness and topicality of the information is restricted to gross negligence. Version: 2024-03-12

ECLASS-11.1	27031302
ECLASS-12.0	27031302
ETIM-5.0	EC002486
customs tariff number	85043180
GTIN	4048879078726
Packaging unit	1

Electrical data | Supply

Power frequency	50 ... 60 Hz
-----------------	--------------

Electrical data | Input

Input voltage 1 AC	230 V
Input voltage 2 AC	400 V
Input voltage AC	208, 230, 380, 400, 420, 440, 460, 480, 500, 525, 550
Input current at input voltage 1 AC	4,73 A
Input current at input voltage 2 AC	2,72 A
Inrush current at input voltage 1	66 A
Inrush current at input voltage 2	38 A
Short-circuit current at input voltage 1	148 A
Short-circuit current at input voltage 2	85 A

Electrical data | Output

Output voltage	1 × 230 / 1 × 115 / 2 × 115 V AC
Output voltage AC 1	230 V
Output voltage AC 2	115 V
Output voltage adjustable	yes
Power rating AC max.	1000 VA

Device protection | Electrical

Insulation test voltage input - output	4 kV
--	------

Mechanical data | Mounting data

Suitable for mounting type	Schlüssellochauhängung
Mounting dimension a	102 mm
Mounting dimension b	135 mm
Mounting dimension c	7 mm
Height	128 mm
Width	174 mm
Depth	160 mm
Diameter bore	7 mm
Length bore	11 mm

Environmental characteristics | Climatic

Operating temperature min.	-20 °C
Operating temperature max.	40 °C
Storage temperature min.	-40 °C
Storage temperature max.	80 °C

Conformity

Product standard	EN 61558-1, EN 61558-2-4, EN 62041 category 0
------------------	---

Connection type 5

Connection type 1	Input
Connection type 2	Input
Connection type 3	Output
Connection type 4	Output
Connection	Screw terminals SK
Family construction form	terminal
Gender	female

No. of poles	8
PIN 1	1
PIN 2	2
PIN 3	3
PIN 4	4
PIN 5	5
PIN 6	6
PIN 7	7
PIN 8	8
Connection	Plug-in terminals RK
Family construction form	terminal
Gender	female
No. of poles	8
PIN 1	1
PIN 2	2
PIN 3	3
PIN 4	4
PIN 5	5
PIN 6	6
PIN 7	7
PIN 8	8
Connection	Screw terminals SK
Family construction form	terminal
Gender	female
No. of poles	4
PIN 1	9
PIN 2	10
PIN 3	11
PIN 4	12
Connection	Plug-in terminals RK
Family construction form	terminal
Gender	female
No. of poles	4
PIN 1	9
PIN 2	10
PIN 3	11
PIN 4	12
Connection	Screw terminals SK
Family construction form	terminal
Gender	female
Color contact carrier	metallic
No. of poles	1
PIN 1	PE