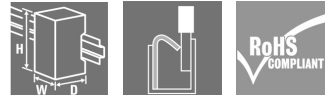

ACT20P-BRIDGE-P

Weidmüller Interface GmbH & Co. KG
Klingenbergstraße 26
D-32758 Detmold
Germany

www.weidmueller.com

Product image, Similar to illustration**ACT20P: The flexible solution**

- Precise and highly functional signal converters
- Release levers simplify handling

General ordering data

Version	Measuring bridge converter, Input : Resistance measuring bridge, Output : 0(4)-20 mA, 0-10 V
Order No.	2456820000
Type	ACT20P-BRIDGE-P
GTIN (EAN)	4050118471762
Qty.	1 pc(s).

Creation date December 29, 2023 4:53:48 AM CET

Catalogue status 09.12.2023 / We reserve the right to make technical changes.

ACT20P-BRIDGE-P

Weidmüller Interface GmbH & Co. KG

Klingenbergstraße 26

D-32758 Detmold

Germany

www.weidmueller.com

Technical data

Dimensions and weights

Depth	113.6 mm	Depth (inches)	4.472 inch
Height	127.1 mm	Height (inches)	5.004 inch
Width	22.5 mm	Width (inches)	0.886 inch
Net weight	205 g		

Temperatures

Storage temperature	-40 °C...85 °C	Operating temperature	-40 °C...70 °C
Humidity	10...90 %, no condensation		

Input

Bridge sensitivity	1.0 mV / V to 5.0 mV / V	Bridge supply voltage	5 V or 10 V
Input signal	±10 mV / ±20 mV / ±30 mV / ±50 mV	Number of inputs	1
Sensor	Strain gauge resistance, Resistance measurement, Total resistance of all parallel resistance measuring bridges: min. 87 Ω	Sensor supply	120 mA @ 10 V (= 4 x 350 Ω bridge resistors)

Output

Load impedance current	≤ 600 Ω	Output current	0...22 mA (adjustable)
Output voltage, note	0...11 V (adjustable)	Type	active, connected control must be passive
load impedance voltage	600 Ω		

Output (analogue)

Output current	0...22 mA (adjustable)
----------------	------------------------

General data

Configuration	DIP switch and button	Linearity	Typically ± 0.05 % of signal range
Long-term drift	0.1 % / 10.000 h	Power consumption	3 W @ 24 V DC
Rail	TS 35	Repeat accuracy	± 0.05 % of final value
Step response time	< 400 ms (10...90 %)	Temperature coefficient	typ. 0.005 % / °C
Voltage supply	10...60 V DC		

Insulation coordination

EMC standards	EN 61326	Insulation voltage	5.7 kV (input / output, input / supply)
Pollution severity	2	Rated voltage	300 V
Surge voltage category	III		

ACT20P-BRIDGE-P**Weidmüller Interface GmbH & Co. KG**

Klingenbergstraße 26

D-32758 Detmold

Germany

www.weidmueller.com

Technical data**Connection data**

Type of connection	PUSH IN	Tightening torque, min.	0.4 Nm
Tightening torque, max.	0.6 Nm	Clamping range, rated connection	2.5 mm ²
Clamping range, min.	0.5 mm ²	Clamping range, max.	2.5 mm ²
Wire connection cross section AWG, min.	AWG 26	Wire connection cross section AWG, max.	AWG 14
Wire cross-section, solid, min.	0.2 mm ²	Wire cross-section, solid, max.	2.5 mm ²
Wire connection cross section, finely stranded, min.	0.2 mm ²	Wire connection cross section, finely stranded, max.	2.5 mm ²
Wire connection cross-section, finely stranded with wire-end ferrules DIN 46228/4, min.	0.2 mm ²	Wire connection cross-section, finely stranded with wire-end ferrules DIN 46228/4, max.	2.5 mm ²

Classifications

ETIM 6.0	EC002653	ETIM 7.0	EC002653
ETIM 8.0	EC002653	ETIM 9.0	EC002653
ECLASS 9.0	27-21-01-20	ECLASS 9.1	27-21-01-20
ECLASS 10.0	27-21-01-20	ECLASS 11.0	27-21-01-20
ECLASS 12.0	27-21-01-20	ECLASS 13.0	27210120

Environmental Product Compliance

REACH SVHC	Lead 7439-92-1
SCIP	2f6dd957-421a-46db-a0c2-cf1609156924

Important note

Product information	<p>The ACT20P-BRIDGE-P bridge measuring transducer converts measuring bridge voltages into standard signals. Buttons are used for adjustment to the measuring bridge connected. The bridge measuring transducer can supply up to 4 parallel-connected measuring bridges each with 350 Ω. The device supports simple compensation of the tare weight with a separate input for an external button or an external PLC signal. The power supply is galvanically isolated from input and output (3-way isolation).</p> <p>Features</p> <ul style="list-style-type: none"> • 4-wire and 6-wire measurement • Supply of up to 4 parallel-connected measuring bridges each with 350 Ω • Input and output ranges can be adjusted via DIP switches • Tare compensation via external button or PLC signal • Front LED indicates operation status • 3-way galvanic isolation between input, output and power supply
---------------------	--

Approvals

Approvals	
Approvals	CULUS;
ROHS	Conform

ACT20P-BRIDGE-P

Weidmüller Interface GmbH & Co. KG
Klingenbergstraße 26
D-32758 Detmold
Germany

www.weidmueller.com

Technical data**Downloads**

Approval/Certificate/Document of Conformity	Declaration of Conformity
Engineering Data	CAD data – STEP
Software	DIP switch configuration tool
User Documentation	Device description – Quickstart guide german Device description – Instruction sheet Device description – Quickstart guide english
Catalogues	Catalogues in PDF-format

ACT20P-BRIDGE-P

Weidmüller Interface GmbH & Co. KG
 Klingenbergstraße 26
 D-32758 Detmold
 Germany

www.weidmueller.com

Drawings

Electric symbol

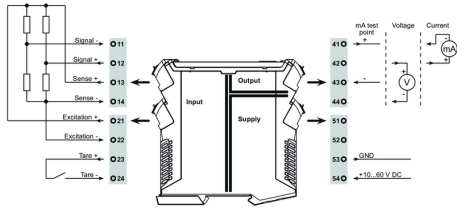

DIP switch setting

Excitation	DIP switch							
	1	2	3	4	5	6	7	8
10 V	■							
5 V		■						

Output	DIP switch							
	1	2	3	4	5	6	7	8
mA		■						
V			■					

Input span	DIP switch							
	1	2	3	4	5	6	7	8
10 mV			■					
20 mV				■				
30 mV					■			
50 mV						■		

Measuring method	DIP switch							
	1	2	3	4	5	6	7	8
4-wire							■	■
6-wire								

■ = ON

Dimensioned drawing, Similar to illustration

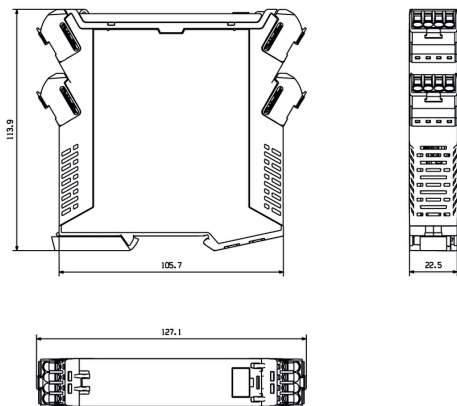

PUSH IN technology

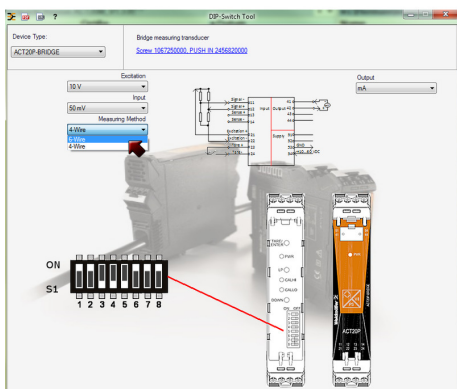
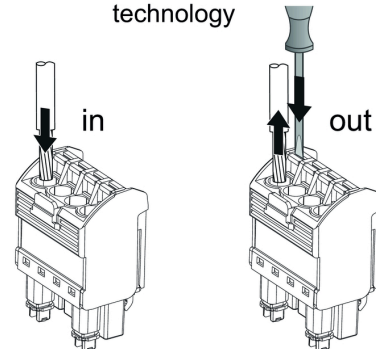

example for DIP switch setting (with ACT20 tool)

ACT20P-BRIDGE-P

Weidmüller Interface GmbH & Co. KG
 Klingenbergstraße 26
 D-32758 Detmold
 Germany

www.weidmueller.com

Accessories

Blank



ESG is the tried-and-tested marker in MultiCard format for use on many well-known electrical devices. The result is high-quality device marking with a high-contrast appearance.

Various types are available for devices from manufacturers like Siemens, ABB, Beckhoff etc. Advantages at a glance:

- Tags for universal usage, self-adhesive or clip-on tags, depending on type
- For aligned equipment, e.g. circuit breakers, we supply ESG markers for clipping onto tag rails
- Individual laser-quality printing according to specifications

For custom printing: Please send us a file of our labeling software M-Print PRO or M-Print PRO Online (without installation) for your labeling specifications.

General ordering data

Type	ESG 6.6/20 BHZ 5.00/04	Version
Order No.	1082540000	ESG, Device markers x 20 mm, PA 66, Colour: white
GTIN (EAN)	4032248845439	
Qty.	200 pc(s).	

ACT20P-BRIDGE-P

Weidmüller Interface GmbH & Co. KG
 Klingenbergstraße 26
 D-32758 Detmold
 Germany

www.weidmueller.com

Accessories

Blank

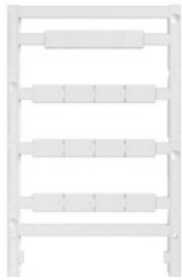

ESG is the tried-and-tested marker in MultiCard format for use on many well-known electrical devices. The result is high-quality device marking with a high-contrast appearance.

Various types are available for devices from manufacturers like Siemens, ABB, Beckhoff etc. Advantages at a glance:

- Tags for universal usage, self-adhesive or clip-on tags, depending on type
- For aligned equipment, e.g. circuit breakers, we supply ESG markers for clipping onto tag rails
- Individual laser-quality printing according to specifications

For custom printing: Please send us a file of our labeling software M-Print PRO or M-Print PRO Online (without installation) for your labeling specifications.

General ordering data

Type	ESG 8/13.5/43.3 SAI AU	Version
Order No.	1912130000	ESG, Device markers x 13.5 mm, PA 66, Colour: Transparent
GTIN (EAN)	4032248541164	
Qty.	5 pc(s).	