

## MTL 1-PHASE SAFETY TRANSFORMER

P: 25VA IN: 230/400VAC +/- 15VAC OUT: 2x24VAC

Single-phase safety transformer  
25 VA  
Isolation class T 60/B

### [Link to Product](#)

#### Illustration

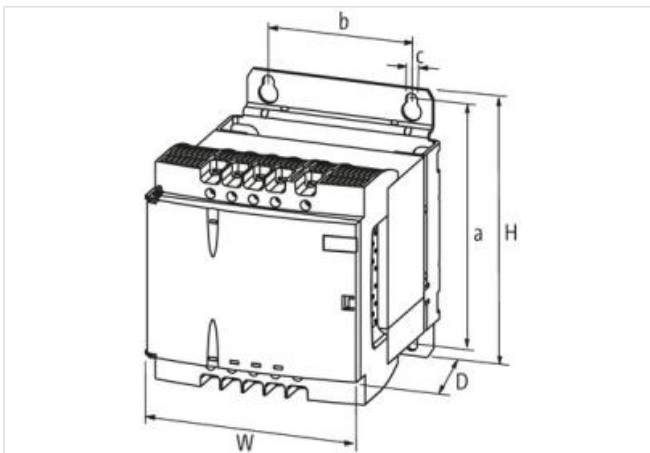
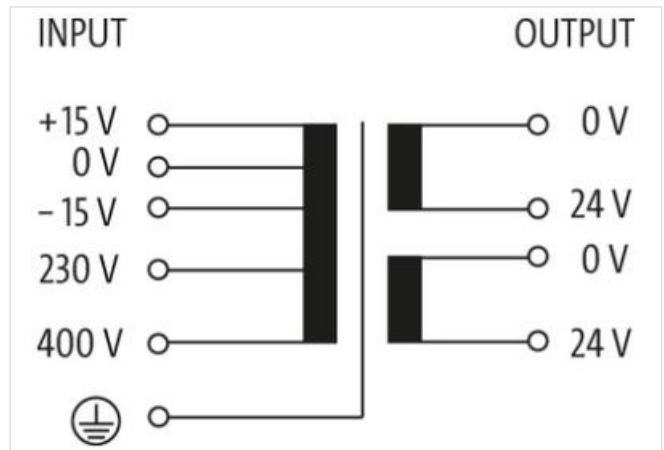

Product may differ from Image

#### Input

Input voltage	230/400 ±15 V AC
Inrush current	1.62 A (230 V AC); 0.94 A (400 V AC)
Short-circuit current	1.61 A (230 V AC); 0.93 A (400 V AC)
Input current	0.19 A (230 V AC); 0.11 A (400 V AC)
Frequency	50...60 Hz

#### Output

Output voltage	1 × 24/1 × 48/2 × 24 V AC
Output rating	25 VA

#### Technical Data

LED display	LED (green) for input voltage
-------------	-------------------------------

#### General data

The information in this Product-PDF has been compiled with the utmost care.  
Liability for the correctness completeness and topicality of the information is restricted to gross negligence. Version: 2023-08-01

Standards	EN 61558-2-4, EN 61558-2-6, EN 62041 category 0
Mounting method	DIN-rail mountable TH35-15 (EN 60715) or for key-hole mounting
Temperature range	-20...+60 °C, no condensation
Test isolation voltage	5.1 kV (prim./sec.)
Drill hole Ø	5.5x9 mm
Fixing centers axbxc	96x60x5.5 mm
Dimensions HxWxD	108x87x98 mm