

MSDD pass-through USB 3.0 form A, 3.0 m cable, design silver

[Link to Product](#)

Illustration

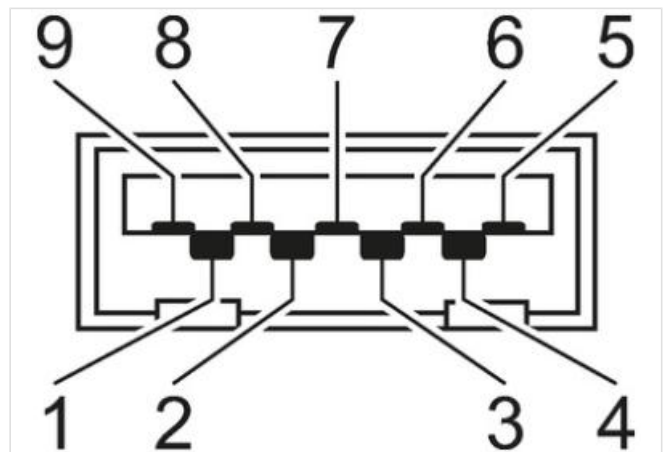
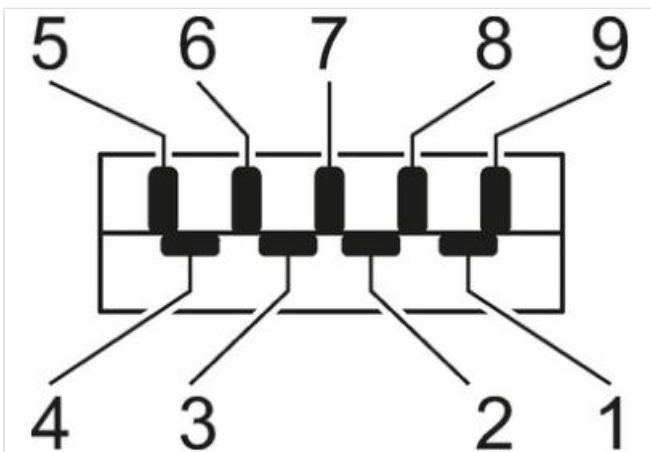
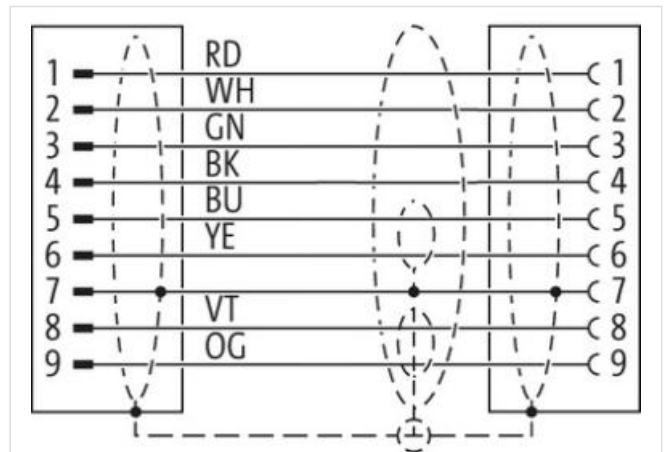
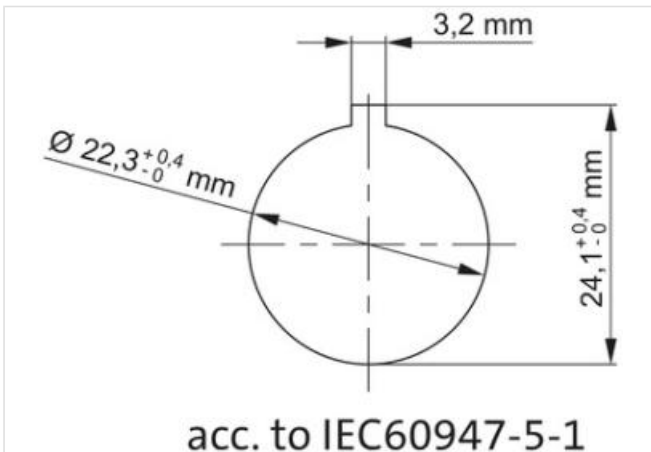
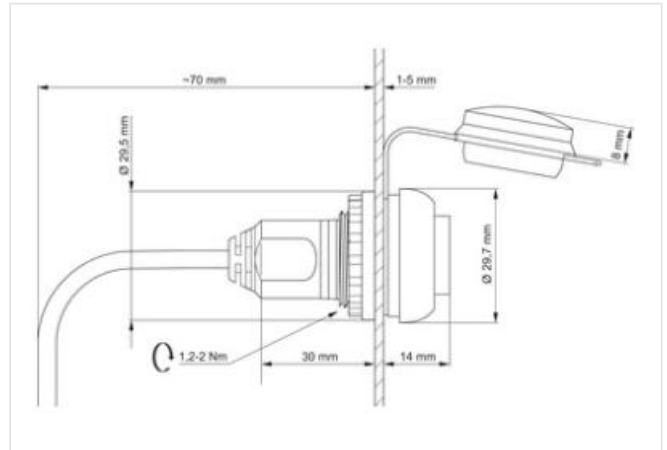

Product may differ from Image

Technical Data

Operating voltage	5 V AC/DC
Operating current	max. 900 mA
Data transmission rate max.	1000 MBit/s
Protection NEMA	Type 2, 3R, 4, 4x, 12, 13 (UL 50E)
Specification	USB: 3.0 (max. 5 Gbit/s)
Mounting depth mounted	approx. 70 mm

General data

Shielded	yes
Cut-out	Ø 22.5 mm

Mechanical protection

Mechanical endurance	1500
----------------------	------

Mechanical data

Diameter	29,5 mm
Depth	30 mm