

MTL 1-PHASE CONTROL AND ISOLATION TRANSFORMER

P: 250VA IN: 230/400VAC +/- 15VAC OUT: 2x115VAC

Single-phase - Control and Isolation Transformers
250 VA
Isolation class T 60/B

Link to Product

Illustration



Product may differ from Image

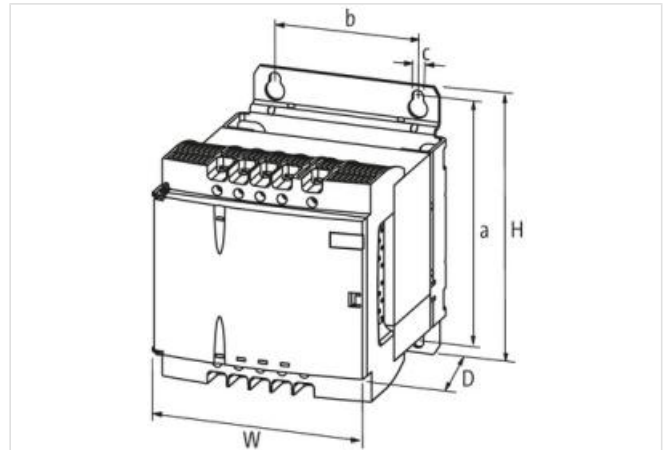

Input

Input voltage	230/400 ±15 V AC
Inrush current	13.7 A (230 V AC); 7.92 A (400 V AC)
Short-circuit current	27.5 A (230 V AC); 15.9 A (400 V AC)
Input current	1.26 A (230 V AC); 0.73 A (400 V AC)
Frequency	50..60 Hz

Output

Output voltage	1× 230, 1× 115, 2× 115 V AC
Output rating	250 VA

Technical Data

LED display	LED (green) for input voltage
-------------	-------------------------------

General data

Standards	EN 61558-1, EN 61558-2-4, EN 62041 category 0
Mounting method	DIN-rail mountable TH35-15 (EN 60715) or for key-hole mounting
Temperature range	-20...+60 °C, no condensation
Test isolation voltage	4 kV (prim./sec.)
Drill hole Ø	6.5×11 mm
Fixing centers a×b×c	136×82×6.5 mm
Dimensions H×W×D	153×123×142 mm