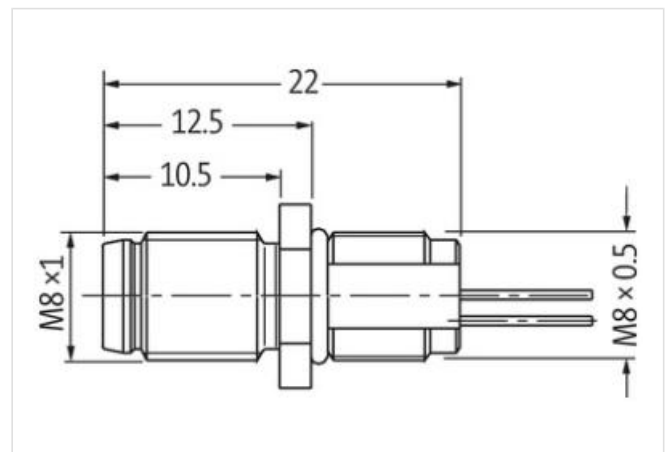
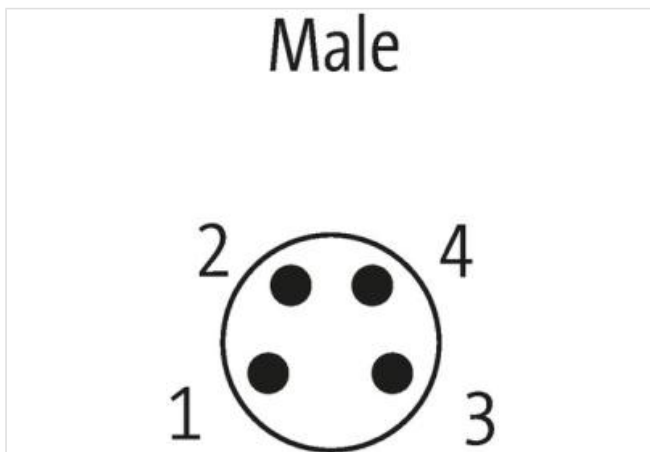
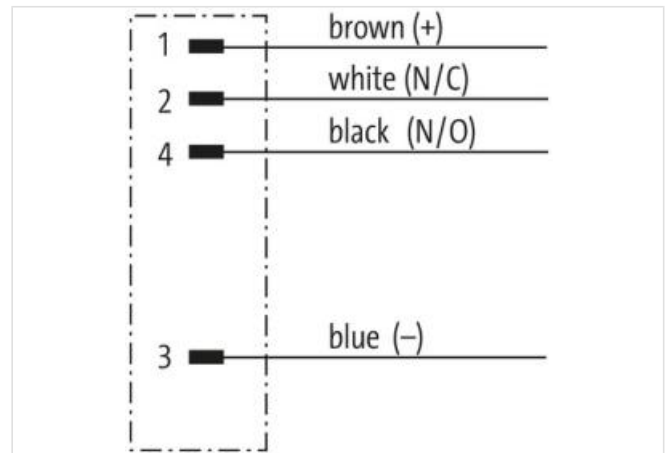

M8 male recept. A-cod. front

PP-wires 4x0.25 0.5m

Flange male
M8, 4-pole
Front mounting
with multi-strand wire

[Link to Product](#)**Illustration**

Product may differ from Image



Cable length 0,5 m

Technical Data

Operating voltage	max. 50 V AC/60 V DC
Rated surge voltage	0.8 kV
Operating current per contact	max. 4 A

Locking of ports	Screw thread (M8×1 mm) recommended torque 0.4 Nm, self-securing
Protection	IP67 inserted and tightened (EN 60529)

General data

Temperature range	-25...+85 °C
-------------------	--------------

Cable

No./diameter of wires	4× 0.25 mm ²
Wire isolation	PP (br, bk, bl, wh)
Outer Ø	1.1 mm ±5%
Cable number	969
Temperature range (fixed)	-40...+90 °C
Temperature range (mobile)	-25...+90 °C
Bend radius (fixed)	5× outer Ø