

ACT20P-CI-CO-P**Weidmüller Interface GmbH & Co. KG**

Klingenbergstraße 26

D-32758 Detmold

Germany

www.weidmueller.com

Product image**ACT20P: The flexible solution**

- Precise and highly functional signal converters
- Release levers simplify handling

General ordering data

Version	Signal converter/insulator, Input : 0(4)-20 mA, Output : 0(4)-20 mA, Signal converter/isolator, HART®
Order No.	2489680000
Type	ACT20P-CI-CO-P
GTIN (EAN)	4050118535150
Qty.	1 pc(s).

Creation date July 13, 2023 11:25:59 AM CEST

Catalogue status 07.07.2023 / We reserve the right to make technical changes.

ACT20P-CI-CO-P**Weidmüller Interface GmbH & Co. KG**

Klingenbergstraße 26

D-32758 Detmold

Germany

www.weidmueller.com

Technical data**Dimensions and weights**

Depth	113.7 mm	Depth (inches)	4.476 inch
Height	127.1 mm	Height (inches)	5.004 inch
Width	12.5 mm	Width (inches)	0.492 inch
Net weight	120 g		

Temperatures

Storage temperature	-40 °C...85 °C	Operating temperature	-20 °C...60 °C
Operating temperature, min.	-20 °C	Operating temperature, max.	60 °C
Humidity	5...95 %, no condensation		

Input

Input current	0...20 mA, 4...20mA	Number of inputs	1
Sensor supply	> 17 V DC at 20 mA, max 30 V @ open circuit, max 50 mA @ short-circuit	Voltage drop	≤ 1 V

Output

Load impedance current	≤ 550 Ω	Number of outputs	1
Output current	0...20 mA (if input: 0...20 mA), 4...20 mA (if input: 4...20 mA), HART® digital signal	Type	active, connected control must be passive

Output (analogue)

Output current	0...20 mA (if input: 0...20 mA), 4...20 mA (if input: 4...20 mA), HART® digital signal
----------------	---

General data

Accuracy	< 0.1 % of end value	Configuration	none
Current consumption	≤60 mA (24V power supply, 20mA output)	Galvanic isolation	3-way isolator, between input/output/supply
Rail	TS 35	Step response time	≤ 0,5 ms
Temperature coefficient	80 ppm/K	Voltage supply	20...30 V DC

Insulation coordination

EMC standards	EN 61010-1:2011, UL 61010-1, EN 61326-1	Galvanic isolation	3-way isolator, between input/output/supply
Impulse withstand voltage	4 kV (1.2/50 μs)	Insulation voltage	2 kV inputs / outputs / power supply
Pollution severity	2	Surge voltage category	III
Test voltage	0.3 kV		

Data for Ex applications (ATEX)

Marking	II 3 G Ex ec IIC T5 Gc
---------	------------------------

ACT20P-CI-CO-P

Weidmüller Interface GmbH & Co. KG
 Klingenbergstraße 26
 D-32758 Detmold
 Germany

www.weidmueller.com

Technical data

Connection data

Type of connection	PUSH IN	Tightening torque, min.	0.4 Nm
Tightening torque, max.	0.6 Nm	Clamping range, rated connection	2.5 mm ²
Clamping range, min.	0.5 mm ²	Clamping range, max.	2.5 mm ²
Wire connection cross section AWG, min.	AWG 26	Wire connection cross section AWG, max.	AWG 14
Wire cross-section, solid, min.	0.2 mm ²	Wire cross-section, solid, max.	2.5 mm ²
Wire connection cross section, finely stranded, min.	0.5 mm ²	Wire connection cross section, finely stranded, max.	2.5 mm ²
Wire connection cross-section, finely stranded with wire-end ferrules DIN 46228/4, min.	0.5 mm ²	Wire connection cross-section, finely stranded with wire-end ferrules DIN 46228/4, max.	2.5 mm ²

Classifications

ETIM 6.0	EC002653	ETIM 7.0	EC002653
ETIM 8.0	EC002653	ECLASS 9.0	27-21-01-20
ECLASS 9.1	27-21-01-20	ECLASS 10.0	27-21-01-20
ECLASS 11.0	27-21-01-20	ECLASS 12.0	27-21-01-20





Environmental Product Compliance

REACH SVHC	Lead 7439-92-1
SCIP	2f6dd957-421a-46db-a0c2-cf1609156924

Important note

Product information	<p>The non-adjustable DC isolating amplifier ACT20P-CI-CO isolates analogue standard current signals from a power source or from a 2- or 3-wire sensor. An analogue input current signal is linearly converted into an analogue output current signal and is galvanically isolated. The power supply is galvanically isolated from the input and output (3-way isolation).</p> <p>Properties</p> <ul style="list-style-type: none"> • HART-compatible for 0.5 - 2.5 kHz • The active or passive mA signal inputs are fully galvanically isolated. • Operating status display on a front panel LED • Galvanic 3-way isolation between input, output and supply.
---------------------	--

Approvals

Approvals	    
Approvals	CULUS;
ROHS	Conform
UL File Number Search	UL Website
Certificate no. (cULus)	E469563
Certificate no. (cULusEX)	E338066

ACT20P-CI-CO-P

Weidmüller Interface GmbH & Co. KG
Klingenbergstraße 26
D-32758 Detmold
Germany

www.weidmueller.com

Technical data**Downloads**

Approval/Certificate/Document of Conformity	IECEX Certification ATEX Certification UL Certification (hazardous location) UL Certification (US-CAN) Declaration of Conformity
Engineering Data	CAD data – STEP
User Documentation	Instruction sheet
Catalogues	Catalogues in PDF-format

ACT20P-CI-CO-P

Weidmüller Interface GmbH & Co. KG
 Klingenbergstraße 26
 D-32758 Detmold
 Germany

www.weidmueller.com

Drawings

Connection diagram

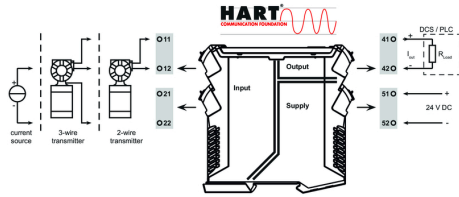

Dimensioned drawing

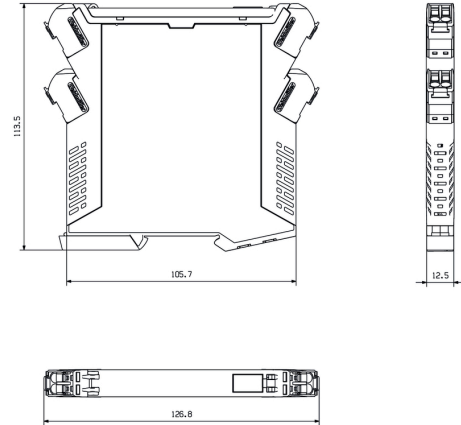

Similar to illustration



**PUSH IN
 technology**

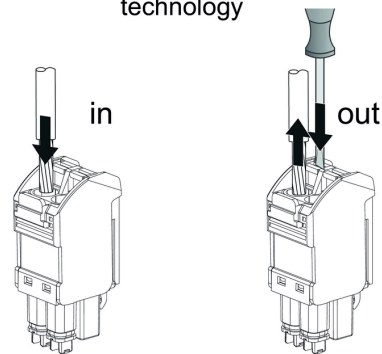

ACT20P-CI-CO-P

Weidmüller Interface GmbH & Co. KG
 Klingenbergstraße 26
 D-32758 Detmold
 Germany

www.weidmueller.com

Accessories

Blank



ESG is the tried-and-tested marker in MultiCard format for use on many well-known electrical devices. The result is high-quality device marking with a high-contrast appearance.

Various types are available for devices from manufacturers like Siemens, ABB, Beckhoff etc. Advantages at a glance:

- Tags for universal usage, self-adhesive or clip-on tags, depending on type
- For aligned equipment, e.g. circuit breakers, we supply ESG markers for clipping onto tag rails
- Individual laser-quality printing according to specifications

For custom printing: Please send us a file of our labeling software M-Print PRO or M-Print PRO Online (without installation) for your labeling specifications.

General ordering data

Type	ESG 6.6/11 BHZ 5.00/02	Version
Order No.	1082490000	ESG, Device markers x 11 mm, PA 66, Colour: white
GTIN (EAN)	4032248845330	
Qty.	200 pc(s).	

ACT20P-CI-CO-P

Weidmüller Interface GmbH & Co. KG
 Klingenbergstraße 26
 D-32758 Detmold
 Germany

www.weidmueller.com

Accessories

Blank

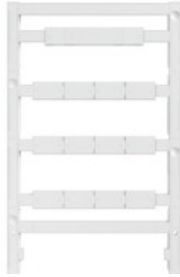

ESG is the tried-and-tested marker in MultiCard format for use on many well-known electrical devices. The result is high-quality device marking with a high-contrast appearance.

Various types are available for devices from manufacturers like Siemens, ABB, Beckhoff etc. Advantages at a glance:

- Tags for universal usage, self-adhesive or clip-on tags, depending on type
- For aligned equipment, e.g. circuit breakers, we supply ESG markers for clipping onto tag rails
- Individual laser-quality printing according to specifications

For custom printing: Please send us a file of our labeling software M-Print PRO or M-Print PRO Online (without installation) for your labeling specifications.

General ordering data

Type	ESG 8/13.5/43.3 SAI AU	Version
Order No.	1912130000	ESG, Device markers x 13.5 mm, PA 66, Colour: Transparent
GTIN (EAN)	4032248541164	
Qty.	5 pc(s).	