

DRM270024LT

Weidmüller Interfaces GmbH & Co. KG

Postfach 3030

32760 Detmold

Tel. +49 5231 14-0

Fax. +49 5231 14-2083

info@weidmueller.com

www.weidmueller.com

Product image



Similar to illustration

Individual relays within the D-SERIES DRM

- 2 CO contacts
- AC coils
- With integrated status LED and test button

General ordering data

Version	D-SERIES DRM, Relay, Number of contacts: 2, CO contact, AgNi flash gold-plated, Rated control voltage: 24 V DC, Continuous current: 10 A, Plug-in connection
Order No.	7760056069
Type	DRM270024LT
GTIN (EAN)	4032248855865
Qty.	20 pc(s).

DRM270024LT

Weidmüller Interfaces GmbH & Co. KG

Postfach 3030

32760 Detmold

Tel. +49 5231 14-0

Fax. +49 5231 14-2083

info@weidmueller.com

www.weidmueller.com

Technical data

Dimensions and weights

Depth	35.7 mm	Depth (inches)	1.406 inch
Height	27.4 mm	Height (inches)	1.079 inch
Width	21 mm	Width (inches)	0.827 inch
Net weight	35.45 g		

Temperatures

Storage temperature	-40 °C...70 °C	Operating temperature	-40 °C...60 °C
Operating temperature, min.	-40 °C	Operating temperature, max.	60 °C
Humidity	35...85 % rel. humidity, no condensation		

Rated data UL

Certificate No. (cURus) E312083

Control side

Rated control voltage	24 V DC	Rated current DC	37.8 mA
Power rating	0.9 W	Pull-in/drop-out voltage, typ.	18 V / 2.4 V DC
Coil resistance	650 Ω ± 10 %	Coil tolerance	10 %
Status indicator	Green LED		

Load side

Rated switching voltage	250 V AC	Continuous current	10 A
Max. switching frequency at rated load	0.1 Hz	Inrush current	20 A / 50 ms
AC switching capacity (resistive), max.	2500 VA	DC switching capacity (resistive), max.	240 W @ 24 V
Switch-on delay	< 20 ms	Switch-off delay	< 20 ms
Contact type	2 CO contact (AgNi flash gold-plated)	Mechanical service life	20 x 10 ⁶ switching cycles
Min. switching power	10 mA @ 12 V, 100 mA @ 5 V		

General data

Test button available	Yes		
Version of test button	Lockable test button, Momentary test button		
Mechanical switch position indicator	Yes		
Colour	Transparent		
UL94 flammability rating component	Component	Relay cover	
	UL94 flammability rating	V-2	
	Component	Relay baseplate	
	UL94 flammability rating	V-0	
	Component	Relay status indicator	
	UL94 flammability rating	HB	
	Component	Relay test button	
	UL94 flammability rating	HB	

DRM270024LT

Weidmüller Interfaces GmbH & Co. KG

Postfach 3030

32760 Detmold

Tel. +49 5231 14-0

Fax. +49 5231 14-2083

info@weidmueller.com

Technical data

Insulation coordination

Rated voltage	250 V	Pollution severity	www.weidmueller.com
Surge voltage category	III	Clearance and creepage distances for control side - load side	≥ 5.5 mm
Dielectric strength for control side - load side	1.8 kV _{eff} / 1 min.	Dielectric strength of neighbouring contacts	1 kV _{eff} / 1 min
Dielectric strength of open contact	1 kV _{eff} / 1 min	Impulse withstand voltage	6 kV (1.2/50 μs)
Protection degree	IP20		

Further details of approvals / standards

Certificate No. (cURus) E312083

Connection data

Wire connection method Plug-in connection

Classifications

ETIM 6.0	EC001437	ETIM 7.0	EC001437
ETIM 8.0	EC001437	ECLASS 9.0	27-37-16-01
ECLASS 9.1	27-37-16-01	ECLASS 10.0	27-37-16-01
ECLASS 11.0	27-37-16-01	ECLASS 12.0	27-37-16-01

Environmental Product Compliance

REACH SVHC Lead 7439-92-1

Approvals

Approvals



ROHS	Conform
UL File Number Search	UL Website
Certificate No. (cURus)	E312083

Downloads

Approval/Certificate/Document of Conformity	EU Konformitätserklärung / EU Declaration of Conformity
Engineering Data	CAD data – STEP
Engineering Data	WSCAD, Zuken E3.S
Product Change Notification	20230124 Product consolidation D-SERIES DRM relays 20230124 Produktkonsolidierung D-SERIES DRM Relais
Catalogues	Catalogues in PDF-format
Brochures	

Creation date March 1, 2023 8:42:49 AM CET

Catalogue status 18.02.2023 / We reserve the right to make technical changes.

3

DRM270024LT

Weidmüller Interfaces GmbH & Co. KG

Postfach 3030

32760 Detmold

Tel. +49 5231 14-0

Fax. +49 5231 14-2083

info@weidmueller.com

Drawings

Wiring diagram

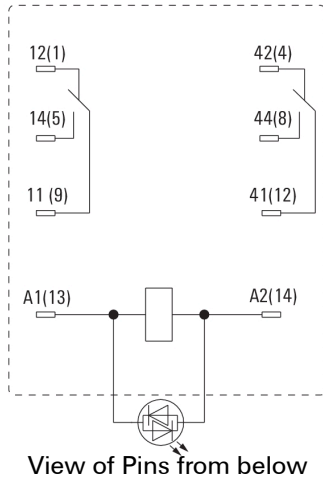

Graph

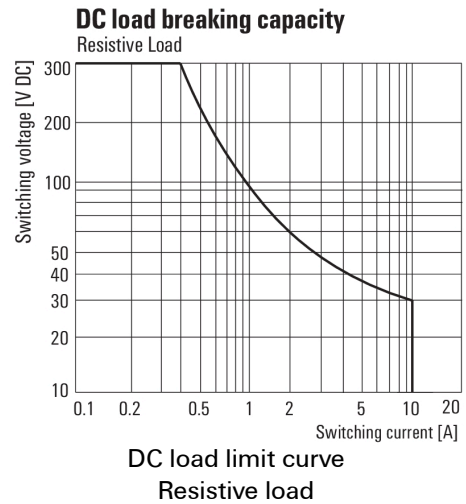

Graph

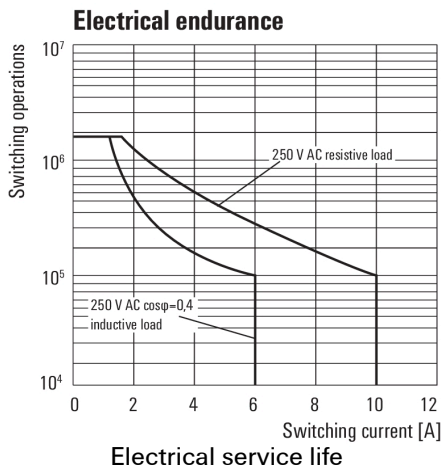

Graph

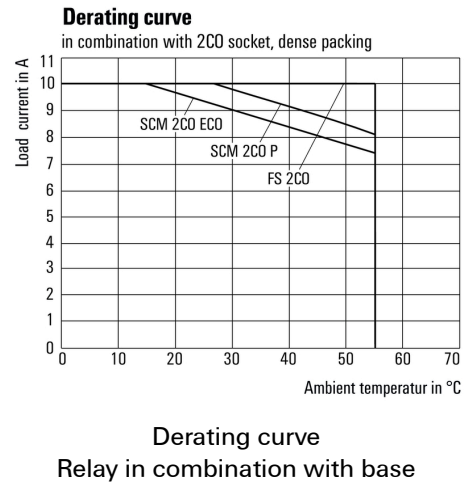

Graph

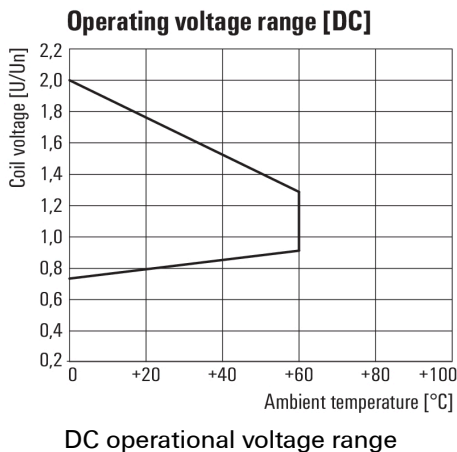

Dimensional drawing

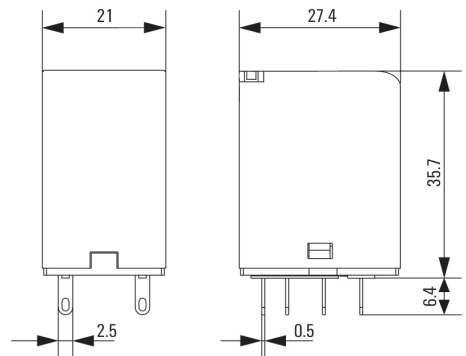

Data sheet

DRM270024LT

Weidmüller Interfaces GmbH & Co. KG

Postfach 3030

32760 Detmold

Tel. +49 5231 14-0

Fax. +49 5231 14-2083

info@weidmueller.com

www.weidmueller.com

Drawings

Miscellaneous

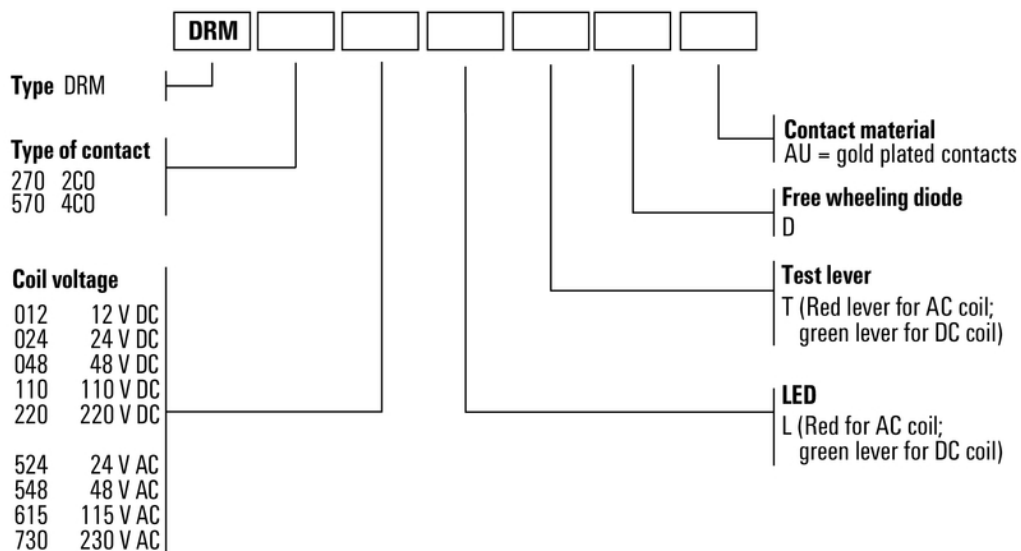

Type codes