

Redundancy module - QUINT4-S-ORING/12-24DC/1X40



2907752

<https://www.phoenixcontact.com/pc/products/2907752>

Please be informed that the data shown in this PDF document is generated from our Online Catalog. Please find the complete data in the user documentation. Our General Terms of Use for Downloads are valid.



Active QUINT single redundancy module for DIN rail mounting, input: 12 V DC ... 24 V DC, output: 12 V DC ... 24 V DC / 1 x 40 A, incl. mounted UTA 107/30 universal DIN rail adapter

Product Description

Active redundancy module for superior system availability and maximum operational reliability. QUINT S-ORING enables the separate structuring of a redundant system. In combination with the new QUINT POWER power supply, the redundant system is monitored continuously.

Your advantages

- Consistent redundancy up to the load
- Input voltage and decoupling section monitored on a permanent basis
- Save energy by decoupling with MOSFET

Commercial Data

Item number	2907752
Packing unit	1 pc
Minimum order quantity	1 pc
Product Key	CMRI43
Catalog Page	Page 304 (C-4-2019)
GTIN	4055626231907
Weight per Piece (including packing)	698.4 g
Weight per Piece (excluding packing)	698.4 g
Customs tariff number	85049090
Country of origin	CN

Redundancy module - QUINT4-S-ORING/12-24DC/1X40



2907752

<https://www.phoenixcontact.com/pc/products/2907752>

Technical Data

Input data

DC operation

Nominal input voltage range	12 V DC ... 24 V DC
Input voltage range	8 V DC ... 30 V DC
Typical national grid voltage	12 V DC 24 V DC
Voltage type of supply voltage	DC
Current consumption	40 A
Static Boost ($I_{Stat.Boost}$)	45 A
Dynamic Boost ($I_{Dyn.Boost}$)	60 A (5 s)
Selective Fuse Breaking (I_{SFB})	215 A (15 ms)
Reverse polarity protection	< yes60 V
Nominal input current (I_N)	40 A (-40 °C ... 60 °C)
Input current I_{Static}	45 A (40 °C)
Input current $I_{Dynamic}$	60 A (5 s)
Input current I_{SFB}	215 A (15 ms)
Transient surge protection	Varistor
Voltage drop, input/output	0.1 V

Output data

Efficiency	typ. 99.1 % (12 V DC) typ. 99.3 % (24 V DC)
Output voltage	U_{in}
Output voltage range	8 V DC ... 30 V DC
Nominal output current (I_N)	40 A
Static Boost ($I_{Stat.Boost}$)	45 A
Dynamic Boost ($I_{Dyn.Boost}$)	60 A (5 s)
Selective Fuse Breaking (I_{SFB})	215 A (15 ms)
Derating	60 °C ... 70 °C (2.5%/K)
Power loss nominal load max.	6.5 W ($I_{OUT} = 40$ A) 6 W ($I_{OUT} = 40$ A)
Connection in series	No

Signal: OK, 13/14

Output description	Group contact
Maximum switching voltage	max. 30 V AC/DC
Maximum inrush current	≤ 100 mA (short-circuit-proof)

Signal relay 13/14

Default	open
Additional text	$U_{IN} < 8$ V DC

Redundancy module - QUINT4-S-ORING/12-24DC/1X40



2907752

<https://www.phoenixcontact.com/pc/products/2907752>

Signal relay 13/14

Default	closed
Additional text	$U_{IN} > 8 \text{ V DC}$

Signal relay 13/14

Default	open
Additional text	Redundancy module defective

Connection data

Input

Connection method	Screw connection
Conductor cross section solid min.	0.5 mm ²
Conductor cross section solid max.	16 mm ²
Conductor cross section flexible min.	0.5 mm ²
Conductor cross section flexible max.	16 mm ²
Single conductor/flexible terminal point with ferrule with plastic sleeve, min.	0.5 mm ²
Single conductor/flexible terminal point with ferrule with plastic sleeve, max.	16 mm ²
Single conductor/flexible terminal point with ferrule without plastic sleeve, min.	0.5 mm ²
Single conductor/flexible terminal point with ferrule without plastic sleeve, max.	16 mm ²
Conductor cross section AWG min.	20
Conductor cross section AWG max.	6
Stripping length	10 mm
Screw thread	M4
Tightening torque, min	1.2 Nm
Tightening torque max	1.5 Nm

Output

Connection method	Screw connection
Conductor cross section solid min.	0.5 mm ²
Conductor cross section solid max.	16 mm ²
Conductor cross section flexible min.	0.5 mm ²
Conductor cross section flexible max.	16 mm ²
Single conductor/flexible terminal point with ferrule with plastic sleeve, min.	0.5 mm ²
Single conductor/flexible terminal point with ferrule with plastic sleeve, max.	16 mm ²
Single conductor/flexible terminal point with ferrule without plastic sleeve, min.	0.5 mm ²
Single conductor/flexible terminal point with ferrule without plastic sleeve, max.	16 mm ²
Conductor cross section AWG min.	20
Conductor cross section AWG max.	6

Redundancy module - QUINT4-S-ORING/12-24DC/1X40



2907752

<https://www.phoenixcontact.com/pc/products/2907752>

Stripping length	10 mm
Screw thread	M4
Tightening torque, min	1.2 Nm
Tightening torque max	1.5 Nm

Signal

Connection method	Push-in connection
Conductor cross section solid min.	0.2 mm ²
Conductor cross section solid max.	1.5 mm ²
Conductor cross section flexible min.	0.2 mm ²
Conductor cross section flexible max.	1.5 mm ²
Single conductor/flexible terminal point with ferrule with plastic sleeve, min.	0.2 mm ²
Single conductor/flexible terminal point with ferrule with plastic sleeve, max.	0.75 mm ²
Single conductor/flexible terminal point with ferrule without plastic sleeve, min.	0.2 mm ²
Single conductor/flexible terminal point with ferrule without plastic sleeve, max.	1.5 mm ²
Conductor cross section AWG min.	24
Conductor cross section AWG max.	16
Stripping length	8 mm

LED signaling

Types of signaling	Relay contact, floating, current limited
--------------------	--

Signal output: OK, 13/14

Signal threshold $U_{in} < 8$ V DC	LED off, input voltage not present or short circuit at redundancy module output
Signal threshold $U_{in} > 8$ V DC	LED lights up green, input voltage present
Redundancy module defective	LED lights up red, redundancy module needs to be factory tested

Electrical properties

Insulation voltage input, output / housing	500 V DC
--	----------

Product properties

Product type	Redundancy module
Product family	QUINT S-ORING
MTBF (IEC 61709, SN 29500)	> 25297000 h (25 °C)
	> 15153000 h (40 °C)
	> 7449000 h (60 °C)

Insulation characteristics

Protection class	III
Degree of pollution	2

Life expectancy (electrolytic capacitors)

Current	40 A
---------	------

Redundancy module - QUINT4-S-ORING/12-24DC/1X40

2907752

<https://www.phoenixcontact.com/pc/products/2907752>

Temperature	40 °C
Time	186000 h
Additional text	12 V DC

Life expectancy (electrolytic capacitors)

Current	40 A
Temperature	40 °C
Time	123000 h
Additional text	24 V DC

Dimensions

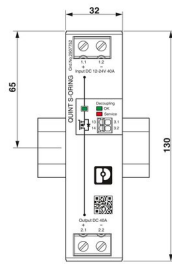
Dimensional drawing	
Width	32 mm
Height	130 mm
Depth	125 mm

Installation dimensions

Installation distance right/left	0 mm / 0 mm
Installation distance top/bottom	40 mm / 20 mm

Alternative assembly

Width	122 mm
Height	130 mm
Depth	35 mm

Mounting

Mounting type	DIN rail mounting
Assembly instructions	alignable: $P_N \geq 50\%$, 5 mm horizontally, 15 mm next to active components, 50 mm vertically alignable: $P_N < 50\%$, 0 mm horizontally, 40 mm vertically top, 20 mm vertically bottom
Mounting position	horizontal DIN rail NS 35, EN 60715

Material specifications

Flammability rating according to UL 94 (housing / terminal blocks)	V0
Housing material	Metal
Type of housing	Aluminum (AlMg3)
Hood version	Galvanized sheet steel, free from chrome (VI)
Housing material	Aluminum / stainless steel

Redundancy module - QUINT4-S-ORING/12-24DC/1X40



2907752

<https://www.phoenixcontact.com/pc/products/2907752>

Environmental and real-life conditions

Ambient conditions

Degree of protection	IP20
Ambient temperature (operation)	-40 °C ... 70 °C (> 60 °C Derating: 2,5 %/K)
Ambient temperature (storage/transport)	-40 °C ... 85 °C
Maximum altitude	≤ 5000 m (> 2000 m, observe derating)
Climatic class	3K3 (in acc. with EN 60721)
Max. permissible relative humidity (operation)	≤ 95 % (at 25 °C, non-condensing)
Shock	18 ms, 30g, in each space direction (according to IEC 60068-2-27)
Vibration (operation)	< 15 Hz, amplitude ±2.5 mm (according to IEC 60068-2-6) 15 Hz ... 150 Hz, 2.3g, 90 min.

Standards and regulations

Standard – Electronic equipment for use in electrical power installations and their assembly into electrical power installations	EN 50178/VDE 0160 (PELV)
Standard - Electrical safety	EN 60950-1/VDE 0805 (SELV)
Standard – Protection against shock currents, basic requirements for protective separation in electrical equipment	EN 50178
Standard – Safety extra-low voltage	IEC 60950-1 (SELV) and EN 60204-1 (PELV)
Standard - Safe isolation	DIN VDE 0100-410

Approval data

Shipbuilding approval	DNV GL
UL approvals	UL/C-UL listed UL 508
	UL/C-UL Recognized UL 60950-1
	UL ANSI/ISA-12.12.01 Class I, Division 2, Groups A, B, C, D (Hazardous Location)

Conformity/Approvals

SIL in accordance with IEC 61508	0
----------------------------------	---

EMC data

Low Voltage Directive	Conformance with Low Voltage Directive 2014/35/EC
Electromagnetic compatibility	Conformance with EMC Directive 2014/30/EU
EMC requirements for noise emission	EN 61000-6-3
	EN 61000-6-4
EMC requirements for noise immunity	EN 61000-6-1
	EN 61000-6-2
Conducted noise emission	EN 55016
	EN 61000-6-3 (Class B)
Interference emission	Interference emission in accordance with EN 61000-6-3 (residential and commercial) and EN 61000-6-4 (industrial)
Noise emission	Additional basic standard EN 61000-6-5 (immunity in power station)

Redundancy module - QUINT4-S-ORING/12-24DC/1X40



2907752

<https://www.phoenixcontact.com/pc/products/2907752>

Noise emission	EN 55016
	EN 61000-6-3 (Class B)
Noise immunity	Immunity in accordance with EN 61000-6-1 (residential), EN 61000-6-2 (industrial), and EN 61000-6-5 (power station equipment zone 1, 2)
DNV GL conducted interference	Class A
Additional text	Area power distribution
DNV GL noise radiation	Class B
Additional text	Bridge and deck area

Electrostatic discharge

Standards/regulations	EN 61000-4-2
-----------------------	--------------

Electrostatic discharge

Contact discharge	8 kV (Test Level 4)
Discharge in air	15 kV (Test Level 4)
Comments	Criterion B

Electromagnetic HF field

Standards/regulations	EN 61000-4-3
-----------------------	--------------

Electromagnetic HF field

Frequency range	80 MHz ... 1 GHz
Test field strength	20 V/m (Test Level 3)
Frequency range	1 GHz ... 6 GHz
Test field strength	10 V/m (Test Level 3)
Frequency range	1 GHz ... 6 GHz
Test field strength	10 V/m (Test Level 3)
Comments	Criterion A

Fast transients (burst)

Standards/regulations	EN 61000-4-4
-----------------------	--------------

Fast transients (burst)

Input	2 kV (Test Level 4 - asymmetrical)
Output	2 kV (Test Level 4 - asymmetrical)
Signal	2 kV (Test Level 4 - asymmetrical)
Comments	Criterion A

Surge voltage load (surge)

Standards/regulations	EN 61000-4-5
Input	1 kV (Test Level 4 - symmetrical)
	2 kV (Test Level 4 - asymmetrical)
Output	1 kV (Test Level 2 - symmetrical)
	2 kV (Test Level 3 - asymmetrical)
Signal	1 kV (Test Level 2 - asymmetrical)
Comments	Criterion A

Redundancy module - QUINT4-S-ORING/12-24DC/1X40



2907752

<https://www.phoenixcontact.com/pc/products/2907752>

Conducted interference

Standards/regulations	EN 61000-4-6
-----------------------	--------------

Conducted interference

I/O/S	asymmetrical
Frequency range	0.15 MHz ... 80 MHz
Comments	Criterion A
Voltage	10 V (Test Level 3)

Power frequency magnetic field

Standards/regulations	EN 61000-4-8
Frequency	16.67 Hz
	50 Hz
	60 Hz
Test field strength	30 A/m
Additional text	60 s
Comments	Criterion A

Criteria

Criterion A	Normal operating behavior within the specified limits.
Criterion B	Temporary impairment to operational behavior that is corrected by the device itself.

Redundancy module - QUINT4-S-ORING/12-24DC/1X40

2907752

<https://www.phoenixcontact.com/pc/products/2907752>

Drawings

Diagram

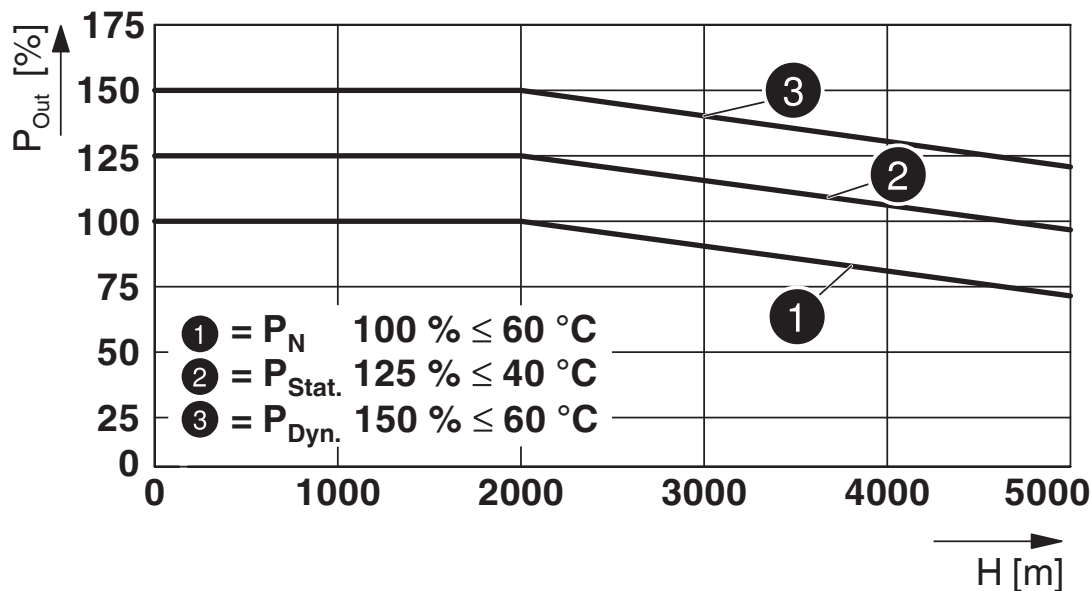

Block diagram

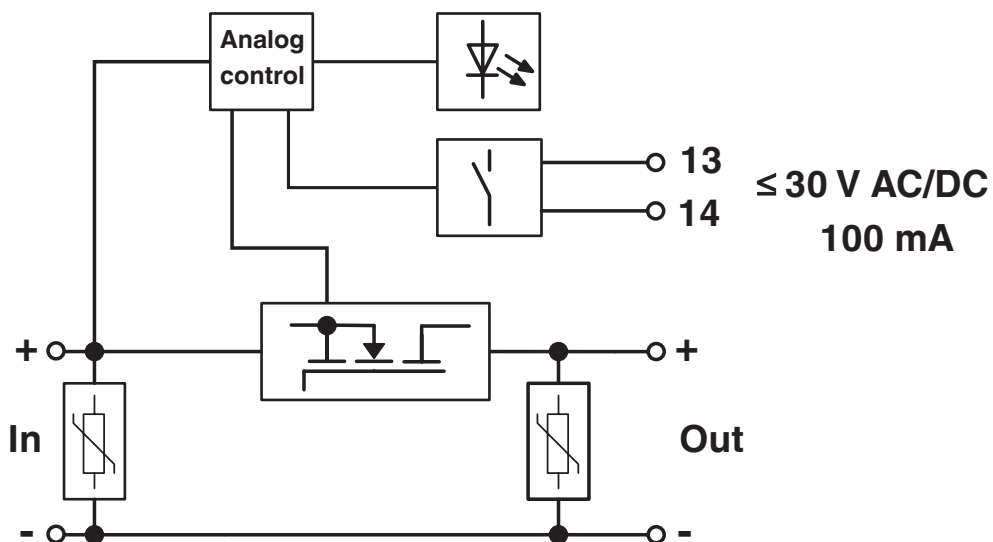

Redundancy module - QUINT4-S-ORING/12-24DC/1X40



2907752

<https://www.phoenixcontact.com/pc/products/2907752>

Dimensional drawing

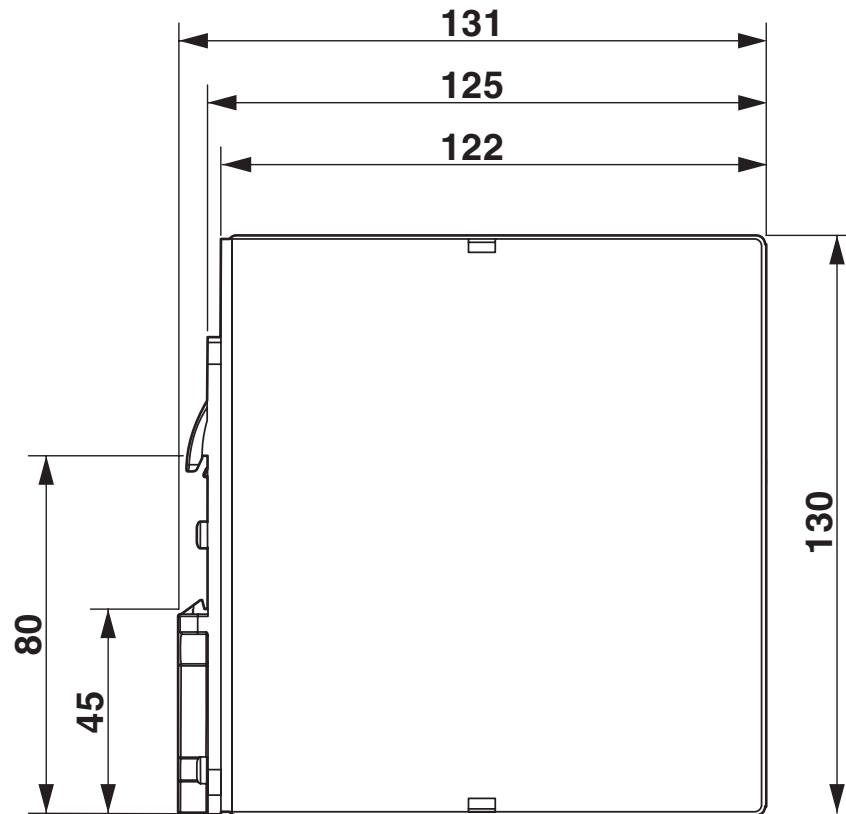

Redundancy module - QUINT4-S-ORING/12-24DC/1X40



2907752

<https://www.phoenixcontact.com/pc/products/2907752>

Dimensional drawing

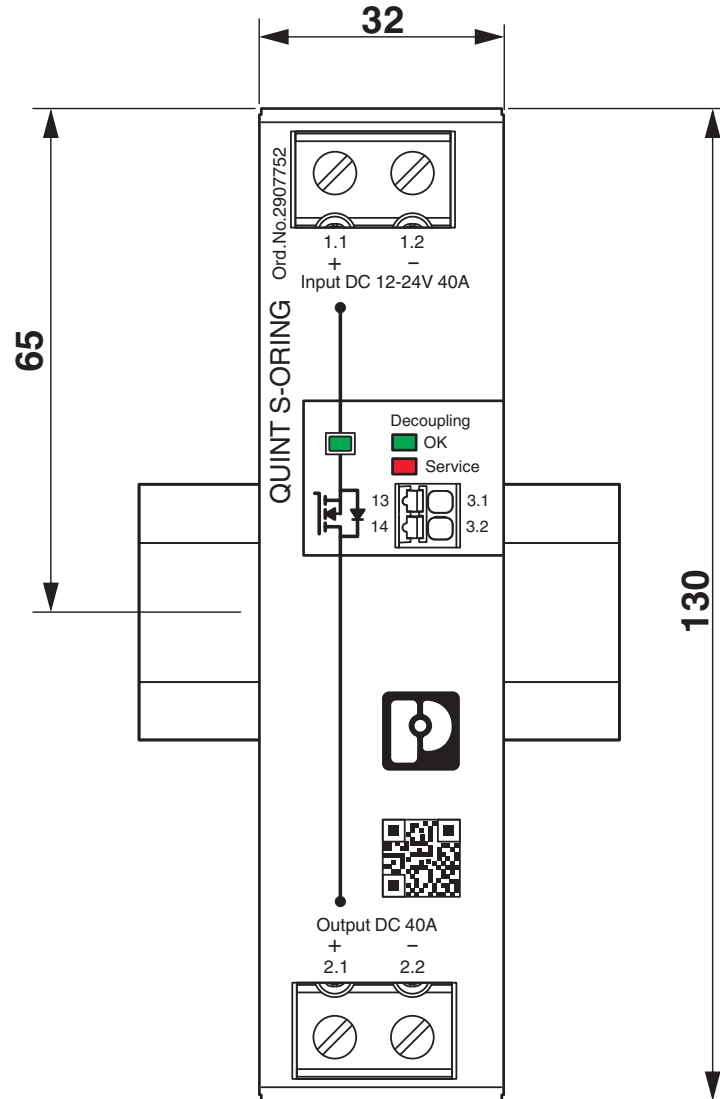

Redundancy module - QUINT4-S-ORING/12-24DC/1X40



2907752

<https://www.phoenixcontact.com/pc/products/2907752>

Diagram

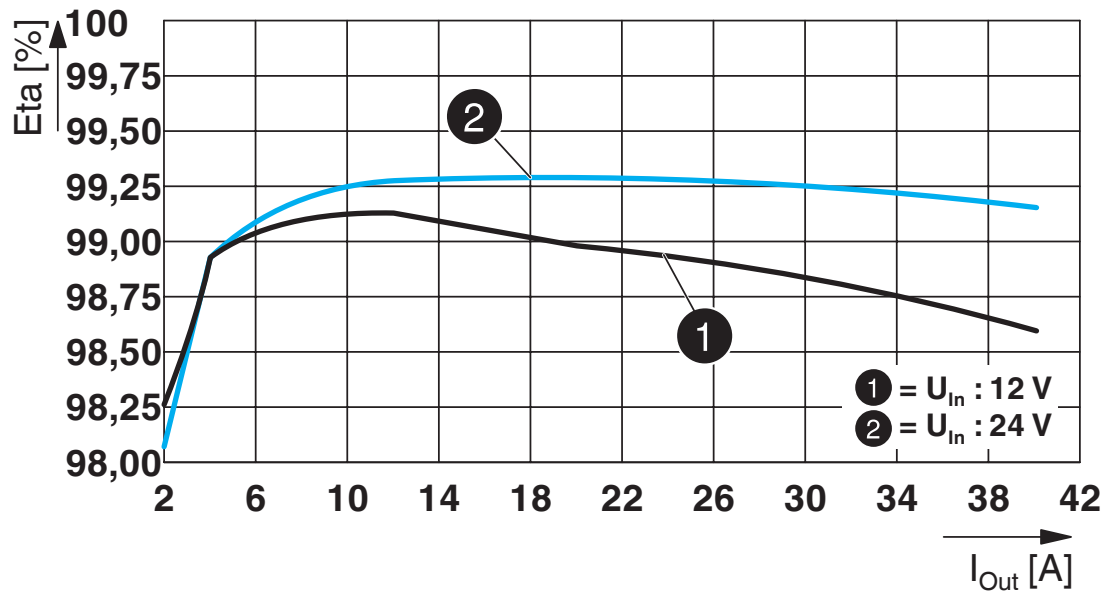

Redundancy module - QUINT4-S-ORING/12-24DC/1X40



2907752

<https://www.phoenixcontact.com/pc/products/2907752>

Approvals



cUL Recognized
Approval ID: FILE E 211944



UL Recognized
Approval ID: FILE E 211944



EAC
Approval ID: RU S-DE.BL08.W.00764



UL Listed
Approval ID: FILE E 123528



cUL Listed
Approval ID: FILE E 123528

DNV

Approval ID: TAA000011F



cUL Listed
Approval ID: FILE E 199827



UL Listed
Approval ID: FILE E 199827

cULus Recognized

cULus Listed

cULus Listed

Redundancy module - QUINT4-S-ORING/12-24DC/1X40



2907752

<https://www.phoenixcontact.com/pc/products/2907752>

Classifications

ECLASS

ECLASS-9.0	27371010
ECLASS-10.0.1	27371010
ECLASS-11.0	27371010

ETIM

ETIM 8.0	EC000683
----------	----------

UNSPSC

UNSPSC 21.0	32151500
-------------	----------

Redundancy module - QUINT4-S-ORING/12-24DC/1X40



2907752

<https://www.phoenixcontact.com/pc/products/2907752>

Environmental Product Compliance

REACH SVHC	Lead 7439-92-1
China RoHS	Environmentally Friendly Use Period = 25;
	For information on hazardous substances, refer to the manufacturer's declaration available under "Downloads"

Redundancy module - QUINT4-S-ORING/12-24DC/1X40

2907752

<https://www.phoenixcontact.com/pc/products/2907752>

Accessories

Mounting adapter

Mounting adapter - UWA 182/52 - 2938235

<https://www.phoenixcontact.com/pc/products/2938235>



Universal wall adapter for securely mounting the device in the event of strong vibrations. The device is screwed directly onto the mounting surface. The universal wall adapter is attached on the top/bottom.

Mounting adapter

Mounting adapter - UTA 107/30 - 2320089

<https://www.phoenixcontact.com/pc/products/2320089>

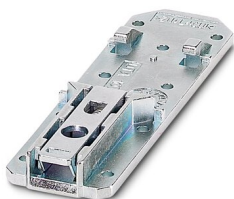

Universal DIN rail adapter

Redundancy module - QUINT4-S-ORING/12-24DC/1X40



2907752

<https://www.phoenixcontact.com/pc/products/2907752>

Mounting adapter

Mounting adapter - QUINT-PS-ADAPTERS7/1 - 2938196

<https://www.phoenixcontact.com/pc/products/2938196>

Assembly adapter for QUINT-PS... power supply on S7-300 rail



Phoenix Contact 2023 © - all rights reserved

<https://www.phoenixcontact.com>

PHOENIX CONTACT GmbH & Co. KG

Flachsmarktstraße 8

D-32825 Blomberg

+49 (0) 5235-3 00

info@phoenixcontact.com