

# Industrial Ethernet Switch - FL SWITCH 2206-2FX ST



2702332

<https://www.phoenixcontact.com/pc/products/2702332>

Please be informed that the data shown in this PDF document is generated from our Online Catalog. Please find the complete data in the user documentation. Our General Terms of Use for Downloads are valid.



Managed Switch 2000, 6 RJ45 ports 10/100 Mbps, 2 ST multi-mode 100 Mbps, PROFINET Conformance-Class B, Extended temperature range

## Your advantages

- VLANs
- MRP (client and manager)
- DHCP client, DHCP server (pool-based and port-based), DHCP option 82
- RSTP
- Ambient temperature -40 °C ... 70 °C
- Web-based management, SNMP
- Slim design
- Configuration memory
- Easy and fast startup and commissioning with the FL NETWORK MANAGER software
- Suitable for PROFINET and EtherNet/IP™ networks

## Commercial Data

Item number	2702332
Packing unit	1 pc
Minimum order quantity	1 pc
Product Key	DNN121
Catalog Page	Page 309 (C-6-2019)
GTIN	4055626128597
Weight per Piece (including packing)	441 g
Weight per Piece (excluding packing)	260 g
Customs tariff number	85176200
Country of origin	DE

## Technical Data

### Dimensions

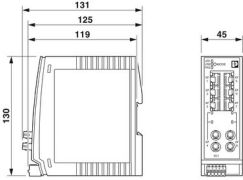
Dimensional drawing	
Width	45 mm
Height	130 mm
Depth	119 mm

### Notes

General	Support by phone or on-site (fee is charged)
Utilization restriction	
EMC note	EMC: class A product, see manufacturer's declaration in the download area

### Material specifications

Housing material	Polycarbonate fiber reinforced
------------------	--------------------------------

### Mounting

Mounting type	DIN rail mounting
---------------	-------------------

### Interfaces

Ethernet (RJ45)	
Connection method	RJ45
Note on the connection method	Auto negotiation and autocrossing
Transmission speed	10/100 Mbps
Transmission physics	Copper
Transmission length	100 m (per segment)
Signal LEDs	Data receive, link status
No. of channels	6 (RJ45 ports)

Ethernet FO	
Number of interfaces	2
Connection method	ST
Transmission speed	100 Mbps (full duplex)
Transmit capacity, minimum	-19 dBm
Transmit capacity, maximum	-14 dBm
Minimum receiver sensitivity	-32 dBm
Maximum receiver sensitivity	-14 dBm

# Industrial Ethernet Switch - FL SWITCH 2206-2FX ST



2702332

<https://www.phoenixcontact.com/pc/products/2702332>

Transmission physics	multi-mode fiberglass
Transmission length	11000 m (fiberglass with F-G 62.5/125 0.7 dB/km F1000)
	6400 m (fiberglass with F-G 50/125 0.7 dB/km F1200)
	3000 m (fiberglass with F-G 62.5/125 2.6 dB/km F600)
	2800 m (fiberglass with F-G 50/125 1.6 dB/km F800)
Wavelength	1300 nm
Signal LEDs	Data receive, link status
No. of channels	2 (ST multi-mode)

## Output data

### Digital

Output name	Alarm output
-------------	--------------

## Product properties

Type	Book type
Product type	Switch
MTTF	Managed Switch 2000
	343.16 Years (SN 29500 standard, temperature 25°C, operating cycle 21%)
	153.37 Years (SN 29500 standard, temperature 40°C, operating cycle 34.25%)
	18.66 Years (SN 29500 standard, temperature 70°C, operating cycle 100%)
Special properties	Extended temperature range
Signal delay	≥ 6.5 μs (Store and Forward mode, 10/100 Mbps, depending on the frame size)

### Insulation characteristics

Protection class	III (VDE 0106)
Degree of pollution	2

### Switch functions

Diagnostic functions	RMON History
	LLDP (Link Layer Discovery Protocol)
	SNMP-Traps
	N:1-Portmirroring
	ACD (Address Conflict Detection)
	SysLog
	CRC-Surveillance
Basic functions	Store-and-forward switch, complies with IEEE 802.3
Signal contact control voltage	typ. 24 V DC
PROFINET conformance class	Conformance-Class B
PROFINET device function	PROFINET device
	Fast Startup
Filter functions	Quality of Service (8 priority classes)
	Class of Service

	DiffServ/DSCP
	Port-Priorisierung
	VLAN (up to 32 VLANs)
	IGMP Snooping/Querier (v1/v2)
	Auto-Query-Port
	Extended Multicast Filtering
IP parameterization	DHCP-Client
	DHCP Option 82 (Relay Agent)
	DHCP server (pool-based, port-based)
	BootP
	DCP (Discovery and Configuration Protocol)
MAC address table	8k
Management	Web-based management (HTTP/HTTPS)
	Role-based user management (LDAP, RADIUS)
	SNMPv1/v2/v3
	Command-line interface (Telnet, SSH)
Redundancy	MRP (Media Redundancy Protocol)
	RSTP (Rapid Spanning Tree Protocol)
	FRD (Fast Ring Detection)
	Large Tree Support
	LACP (Link Aggregation Control Protocol)
	PROFINET S2 system redundancy
Status and diagnostic indicators	LEDs: US1, US2 (power supply), Fail (alarm contact), 2 LEDs per Ethernet port (Link/Activity and Speed)
Additional functions	Transmission of MMS and GOOSE (IEC 61850-8-1)
	Transmission of Modbus/TCP
Time synchronization	SNTP (Simple Network Time Protocol)

## Security functions

Port security	MAC-based, RADIUS (IEEE 802.1X), MAC Authentication Bypass
Basic functions	Store-and-forward switch, complies with IEEE 802.3

## Electrical properties

Local diagnostics	US1/2 Supply voltage US1, US2 Green LED
	FAIL Div. LED red
	LINK Link status Green LED
Maximum power dissipation for nominal condition	6.75 W ( $U_S = \text{Min}$ , $T_{\text{amb}} = \text{Max}$ , $DO_1 = \text{Max}$ )
Test voltage	500 V DC
Test section	for one minute 500 V DC
Transmission medium	Copper
	FO

## Supply

Supply voltage (DC)	24 V DC (redundant)
---------------------	---------------------

2702332

<https://www.phoenixcontact.com/pc/products/2702332>

Supply voltage range	9 V DC ... 57 V DC
Power supply connection	via COMBICON, max. conductor cross section 1.5 mm <sup>2</sup>
Residual ripple	3.6 V <sub>PP</sub> (within the permitted voltage range)
Max. current consumption	1.5 A (U <sub>S</sub> = Min, T <sub>amb</sub> = Max, DO <sub>1</sub> = Max)
Typical current consumption	255 mA (at U <sub>S</sub> = 24 V DC and 25 °C ambient temperature)
Current consumption	260 mA

## Function

Signal contact control voltage	typ. 24 V DC
--------------------------------	--------------

## Connection data

Connection method	Push-in spring connection
Note on the connection method	Use only copper connecting cables providing the permitted temperature range (-40 °C ... 75 °C).
Conductor cross section, rigid	0.25 mm <sup>2</sup> ... 1.5 mm <sup>2</sup>
Conductor cross section, flexible	0.25 mm <sup>2</sup> ... 1.5 mm <sup>2</sup>
Conductor cross section AWG	24 ... 16
Stripping length	9 mm

## Environmental and real-life conditions

### Ambient conditions

Degree of protection	IP20
Ambient temperature (operation)	-40 °C ... 70 °C
Ambient temperature (storage/transport)	-40 °C ... 85 °C
Permissible humidity (operation)	10 % ... 95 % (non-condensing)
Permissible humidity (storage/transport)	10 % ... 95 % (non-condensing)
Shock (operation)	30g (EN 60068-2-27)
Vibration (operation)	in acc. with IEC 60068-2-6: 5g, 150 Hz
Air pressure (operation)	80 kPa ... 110 kPa up to 2000 m above mean sea level (Without derating)
Air pressure (storage/transport)	79 kPa ... 108 kPa up to 2000 m above mean sea level (Without derating)

## Standards and regulations

Free from substances that could impair the application of coating	Yes
---	-----

## Approval data

Shipbuilding approval	Tested in accordance with IEC 60945 and IACS E10
-----------------------	--

### ATEX

Identification	<input type="checkbox"/> II 3 G Ex ec IIC T4 Gc
Certificate	DEMKO 16 ATEX 1709X

### IECEX

Identification	Ex ec IIC T4 Gc
Certificate	IECEX ULD 16.0018 X

2702332

<https://www.phoenixcontact.com/pc/products/2702332>

## UL, USA / Canada

Identification	cULus
----------------	-------

## UL Ex, USA / Canada

Identification	Class I, Division 2, Groups A, B, C, and D, T4
	Class I, Zone 2, AEx ec IIC T4
	Ex ec IIC T4 Gc X
Certificate	E366272
Note	UL 60079-0 Ed. 6 / UL 60079-7 Ed. 5, CSA 22.2 No. 60079-0 Ed. 3 / CSA C22.2 No. 60079-7 Ed. 2

## EAC Ex

Identification	2Ex e IIC T4 Gc X
Certificate	RU C-DE.HB49.B.00118/21

The following continue to apply for EAC Ex:

Identification	При монтаже использовать подходящий допущенный корпус со степенью защиты не ниже IP66.
	На корпусе/шкафу управления должна быть размещена предупреждающая надпись, запрещающая открывать корпус или шкаф во взрывоопасной зоне.
	Эксплуатация устройства допускается только при условии, что все оптические порты заняты подключенными устройствами или закрыты прилагаемыми заглушками.

## CCC / China-Ex

Identification	Ex ec IIC T4 Gc
Certificate	2022122310115629

## Corrosive gas test

Identification	ISA S71.04.2013 G3 Harsh Group A
----------------	----------------------------------

## UKCA Ex (UKEX)

Identification	<input type="checkbox"/> II 3 G Ex ec IIC T4 Gc
Certificate	PxCIMA22UKEX2702910X

## DNV GL data

Temperature	B
Humidity	B
Vibration	A
EMC	B
Enclosure	Required protection according to the Rules shall be provided upon installation on board

## EMC data

Conformance with EMC directives	EN 61000-6-2 EN 61000-4-2 (ESD) Criterion B
	EN 61000-6-2 EN 61000-4-3 (electromagnetic fields) Criterion A
	EN 61000-6-2 EN 61000-4-4 (EFT burst) Criterion A
	EN 61000-6-2 EN 61000-4-5 (surge) Criterion A

# Industrial Ethernet Switch - FL SWITCH 2206-2FX ST



2702332

<https://www.phoenixcontact.com/pc/products/2702332>

	EN 61000-6-2 EN 61000-4-6 (line noise immunity) Criterion A
	EN 61000-6-2 EN 61000-6-4 (interference) Class A
	EN 61000-6-2 EN 61000-6-4 (conducted interference) Class A
Electromagnetic compatibility	Conformance with EMC Directive 2014/30/EU
Noise emission	EN 61000-6-4
Noise immunity	EN 61000-6-2

## LED signaling

Status display	LEDs: US1, US2 (power supply), Fail (alarm contact), 2 LEDs per Ethernet port (Link/Activity and Speed)
----------------	---

# Industrial Ethernet Switch - FL SWITCH 2206-2FX ST



2702332

<https://www.phoenixcontact.com/pc/products/2702332>

## Drawings

Dimensional drawing

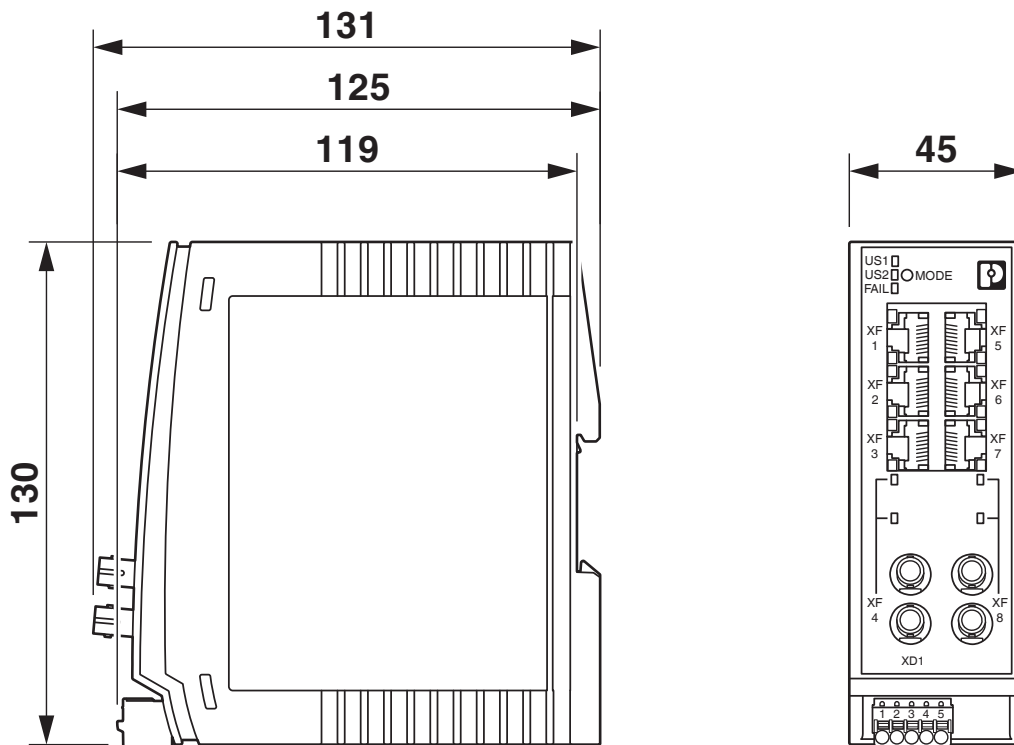



# Industrial Ethernet Switch - FL SWITCH 2206-2FX ST



2702332

<https://www.phoenixcontact.com/pc/products/2702332>

## Approvals



**EAC**

Approval ID: RU\*-DE.\*.B.00741/19



**DNV GL**

Approval ID: TAA00000YV



**LR**

Approval ID: LR22250919TA



**NK**

Approval ID: TA19464M



**BV**

Approval ID: 48146/A1 BV



**UL Listed**

Approval ID: FILE E 238705



**cUL Listed**

Approval ID: FILE E 238705

**BSH**

Approval ID: Nr. 966



**RINA**

Approval ID: ELE162721XG

**ABS**

Approval ID: 21-2066186-PDA



**cUL Listed**

Approval ID: FILE E 366272



**UL Listed**

Approval ID: FILE E 366272

# Industrial Ethernet Switch - FL SWITCH 2206-2FX ST



2702332

<https://www.phoenixcontact.com/pc/products/2702332>



**IECEX**

Approval ID: IECEX ULD 16.0018X



**ATEX**

Approval ID: DEMKO 16 ATEX 1709X

**cULus Listed**

**cULus Listed**

# Industrial Ethernet Switch - FL SWITCH 2206-2FX ST



2702332

<https://www.phoenixcontact.com/pc/products/2702332>

## Classifications

### ECLASS

ECLASS-9.0	19170106
ECLASS-10.0.1	19170401
ECLASS-11.0	19170401

### ETIM

ETIM 8.0	EC000734
----------	----------

### UNSPSC

UNSPSC 21.0	43222600
-------------	----------

2702332

<https://www.phoenixcontact.com/pc/products/2702332>

## Environmental Product Compliance

REACH SVHC	Lead 7439-92-1
China RoHS	Environmentally Friendly Use Period = 50 years
	For information on hazardous substances, refer to the manufacturer's declaration available under "Downloads"

2702332

<https://www.phoenixcontact.com/pc/products/2702332>

## Accessories

### Program / configuration memory

Program / configuration memory - SD FLASH 2GB - 2988162

<https://www.phoenixcontact.com/pc/products/2988162>



Program and configuration memory, for extending the internal flash memory, pluggable, 2 GB.

---

### Network management software

Network management software - FL NETWORK MANAGER BASIC - 2702889

<https://www.phoenixcontact.com/pc/products/2702889>

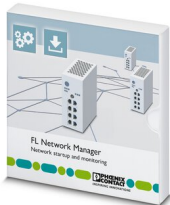

FL Network Manager, SNMP-based configuration and firmware update software, for easy startup of Managed Switches

# Industrial Ethernet Switch - FL SWITCH 2206-2FX ST



2702332

<https://www.phoenixcontact.com/pc/products/2702332>

## DIN rail adapter

DIN rail adapter - FL DIN RA - 2891053

<https://www.phoenixcontact.com/pc/products/2891053>

The FL DIN RA is installed in a standard, 19-inch rack (EIA-310-D, IEC 60297-3-100) to allow DIN rail mounted equipment to be rack mounted.

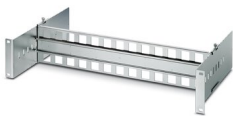

---

## Dust protection

Dust protection - FL RJ45 PROTECT CAP - 2832991

<https://www.phoenixcontact.com/pc/products/2832991>

Dust protection caps for RJ45 socket

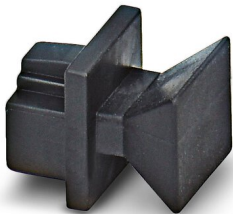

2702332

<https://www.phoenixcontact.com/pc/products/2702332>

## End clamp

End clamp - E/NS 35 N - 0800886

<https://www.phoenixcontact.com/pc/products/0800886>

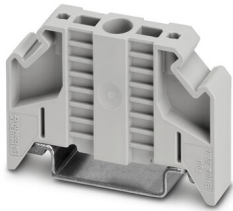

End clamp, width: 9.5 mm, color: gray

---

## PCB connector

PCB connector - FK-MCP 1,5/ 5-ST-3,81GY35BD1-5 - 1015782

<https://www.phoenixcontact.com/pc/products/1015782>



PCB connector, nominal cross section: 1.5 mm<sup>2</sup>, color: light grey, nominal current: 8 A, rated voltage (III/2): 160 V, contact surface: Tin, type of contact: Female connector, number of potentials: 5, number of rows: 1, number of positions: 5, number of connections: 5, product range: FK-MCP 1,5/...-ST, pitch: 3.81 mm, connection method: Push-in spring connection, conductor/PCB connection direction: 0 °, number of solder pins per potential: 1, plug-in system: COMBICON MC 1,5, locking: without, mounting: without, type of packaging: packed in cardboard

# Industrial Ethernet Switch - FL SWITCH 2206-2FX ST



2702332

<https://www.phoenixcontact.com/pc/products/2702332>

## PCB connector

PCB connector - MCVW 1,5/ 5-ST-3,81GY7035BD2DO - 1034096

<https://www.phoenixcontact.com/pc/products/1034096>

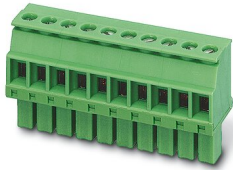

PCB connector, nominal cross section: 1.5 mm<sup>2</sup>, color: light grey, nominal current: 8 A, rated voltage (III/2): 160 V, contact surface: Tin, type of contact: Female connector, number of potentials: 5, number of rows: 1, number of positions: 5, number of connections: 5, product range: MCVW 1,5/...-ST, pitch: 3.81 mm, connection method: Screw connection with tension sleeve, screw head form: L Slotted, conductor/PCB connection direction: -90 °, number of solder pins per potential: 1, plug-in system: COMBICON MC 1,5, locking: without, mounting: without, type of packaging: packed in cardboard

---

## Patch cable

Patch cable - FL CAT5 PATCH 0,5 - 2832263

<https://www.phoenixcontact.com/pc/products/2832263>



Patch cable, CAT5, assembled, 0.5 m



# Industrial Ethernet Switch - FL SWITCH 2206-2FX ST



2702332

<https://www.phoenixcontact.com/pc/products/2702332>

## Patch cable

Patch cable - FL CAT5 PATCH 1,0 - 2832276

<https://www.phoenixcontact.com/pc/products/2832276>

Patch cable, CAT5, assembled, 1 m



---

## Patch cable

Patch cable - FL CAT5 PATCH 2,0 - 2832289

<https://www.phoenixcontact.com/pc/products/2832289>

Patch cable, CAT5, assembled, 2 m



# Industrial Ethernet Switch - FL SWITCH 2206-2FX ST



2702332

<https://www.phoenixcontact.com/pc/products/2702332>

## Patch cable

Patch cable - NBC-R4AC-R4AC-IE8A/.../... - 1411854

<https://www.phoenixcontact.com/pc/products/1411854>

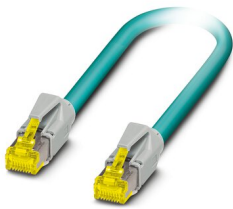

Patch cable, degree of protection: IP20, number of positions: 8, 10 Gbps, CAT6<sub>A</sub>, cable outlet: straight, Ethernet

---

## Patch cable

Patch cable - NBC-R4AC/10G-R4AC/10G-94F/2,0 - 1408360

<https://www.phoenixcontact.com/pc/products/1408360>

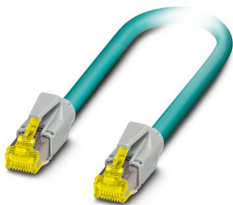

Patch cable, CAT6<sub>A</sub>, 4-pair, shielded, connection not crossed (line), assembled at both ends with RJ45/IP20 connectors, outer sheath material: PUR, length: 2.0 m

# Industrial Ethernet Switch - FL SWITCH 2206-2FX ST



2702332

<https://www.phoenixcontact.com/pc/products/2702332>

## Patch cable

Patch cable - NBC-R4AC/10G-R4AC/10G-94F/3,0 - 1408365

<https://www.phoenixcontact.com/pc/products/1408365>

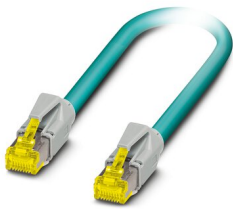

Patch cable, CAT6<sub>A</sub>, 4-pair, shielded, connection not crossed (line), assembled at both ends with RJ45/IP20 connectors, outer sheath material: PUR, length: 3.0 m

---

## Patch cable

Patch cable - NBC-R4AC/1,0-93B/R4AC - 1408968

<https://www.phoenixcontact.com/pc/products/1408968>



Patch cable, degree of protection: IP20, cable length: 1 m, number of positions: 4, 100 Mbps, CAT5, material: PA 6.6, PROFINET

# Industrial Ethernet Switch - FL SWITCH 2206-2FX ST



2702332

<https://www.phoenixcontact.com/pc/products/2702332>

## Patch cable

Patch cable - NBC-R4AC/2,0-93B/R4AC - 1408969

<https://www.phoenixcontact.com/pc/products/1408969>



Patch cable, degree of protection: IP20, cable length: 2 m, number of positions: 4, 100 Mbps, CAT5, material: PA 6.6, PROFINET

---

## Patch cable

Patch cable - NBC-R4AC/5,0-93B/R4AC - 1408970

<https://www.phoenixcontact.com/pc/products/1408970>



Patch cable, degree of protection: IP20, cable length: 5 m, number of positions: 4, 100 Mbps, CAT5, material: PA 6.6, PROFINET

# Industrial Ethernet Switch - FL SWITCH 2206-2FX ST



2702332

<https://www.phoenixcontact.com/pc/products/2702332>

## FO patch cable

FO patch cable - FOC-ST:PA-SC:PA-OM2:D01/1 - 1115574

<https://www.phoenixcontact.com/pc/products/1115574>

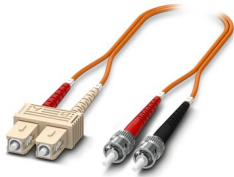

Multi-mode OM2 duplex jumper, ST-SC, UPC polishing, length 1 m

---

## FO patch cable

FO patch cable - FOC-ST:PA-SC:PA-OM2:D01/2 - 1115573

<https://www.phoenixcontact.com/pc/products/1115573>

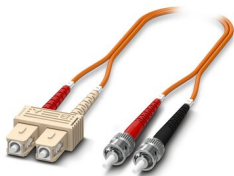

Multi-mode OM2 duplex jumper, ST-SC, UPC polishing, length 2 m

# Industrial Ethernet Switch - FL SWITCH 2206-2FX ST



2702332

<https://www.phoenixcontact.com/pc/products/2702332>

## FO patch cable

FO patch cable - FOC-ST:PA-ST:PA-OM2:D01/1 - 1115560

<https://www.phoenixcontact.com/pc/products/1115560>

Multi-mode OM2 duplex jumper, ST-ST, UPC polishing, length 1 m



---

## FO patch cable

FO patch cable - FOC-ST:PA-ST:PA-OM2:D01/2 - 1115557

<https://www.phoenixcontact.com/pc/products/1115557>

Multi-mode OM2 duplex jumper, ST-ST, UPC polishing, length 2 m



# Industrial Ethernet Switch - FL SWITCH 2206-2FX ST



2702332

<https://www.phoenixcontact.com/pc/products/2702332>

## Fiber optic cable

Fiber optic cable - FOC-LC:PA-ST:PA-OM2:D01/1 - 1115588

<https://www.phoenixcontact.com/pc/products/1115588>

Multi-mode OM2 duplex jumper, LC-ST, UPC polishing, length 1 m

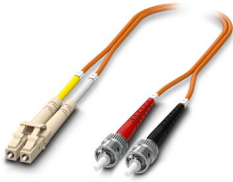

---

## Fiber optic cable

Fiber optic cable - FOC-LC:PA-ST:PA-OM2:D01/2 - 1115587

<https://www.phoenixcontact.com/pc/products/1115587>

Multi-mode OM2 duplex jumper, LC-ST, UPC polishing, length 2 m

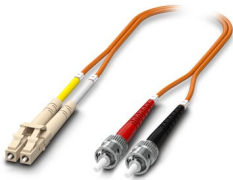

# Industrial Ethernet Switch - FL SWITCH 2206-2FX ST



2702332

<https://www.phoenixcontact.com/pc/products/2702332>

## RJ45 connector

RJ45 connector - VS-08-RJ45-5-Q/IP20 - 1656725

<https://www.phoenixcontact.com/pc/products/1656725>



RJ45 connector, design: RJ45, degree of protection: IP20, number of positions: 8, 1 Gbps, CAT5 (IEC 11801:2002), material: Plastic, connection method: IDC fast connection, connection cross section: AWG 26- 23, cable outlet: straight, color: traffic grey A RAL 7042, Ethernet

---

Phoenix Contact 2023 © - all rights reserved

<https://www.phoenixcontact.com>

PHOENIX CONTACT GmbH & Co. KG

Flachsmarktstraße 8

D-32825 Blomberg

+49 (0) 5235-3 00

[info@phoenixcontact.com](mailto:info@phoenixcontact.com)